

.mdd

Panele i blendy
v7.2022

Zestawienie kolorystyczne - Sonic - panele wolnostojące

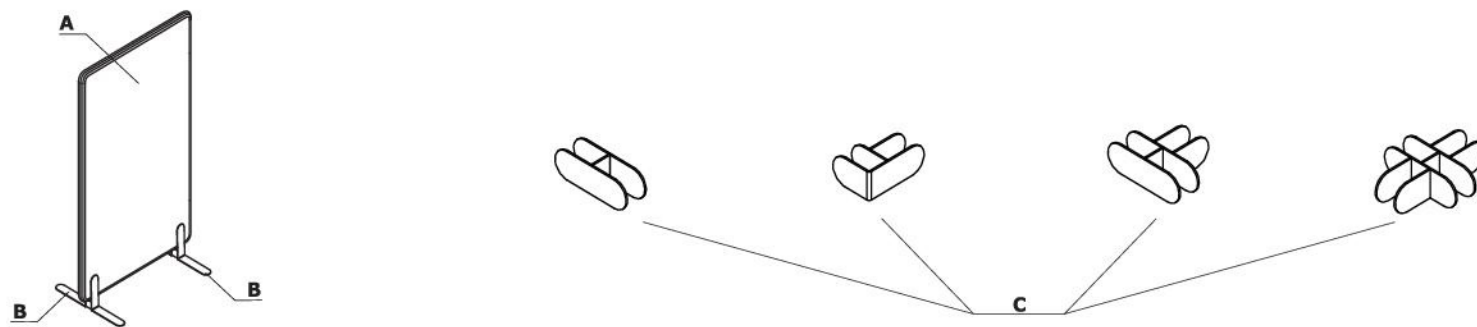

| Materiał | Kolor | Panele wolnostojące | | | | | | | | | | | | | | | |
|----------|---------------------|---------------------|-----------|--------------|--|--|--|--|--|--|--|--|--|--|--|--|--|
| | | A - Panel | B - Stopa | C - Łączniki | | | | | | | | | | | | | |
| Tkanina | Nemo | ✓ | | | | | | | | | | | | | | | |
| | Runner | II grupa ✓ | | | | | | | | | | | | | | | |
| | Medley | II grupa ✓ | | | | | | | | | | | | | | | |
| | **Atlantic | II grupa ✓ | | | | | | | | | | | | | | | |
| | Vita | II grupa ✓ | | | | | | | | | | | | | | | |
| | Mica | II grupa ✓ | | | | | | | | | | | | | | | |
| | Go Check | II grupa ✓ | | | | | | | | | | | | | | | |
| | ****Charles | II grupa ✓ | | | | | | | | | | | | | | | |
| | *Tkanina powierzona | II grupa ✓ | | | | | | | | | | | | | | | |
| | Synergy | III grupa ✓ | | | | | | | | | | | | | | | |
| | ***Silvertex | III grupa ✓ | | | | | | | | | | | | | | | |
| | Tessa | III grupa ✓ | | | | | | | | | | | | | | | |
| | Oceanic | III grupa ✓ | | | | | | | | | | | | | | | |
| | Quest | III grupa ✓ | | | | | | | | | | | | | | | |
| | Grain | III grupa ✓ | | | | | | | | | | | | | | | |
| | Atlas | IV grupa ✓ | | | | | | | | | | | | | | | |

* Zastosowanie tkaniny powierzonej wymaga przeprowadzenia prób tapicerskich, w celu sprawdzenia możliwości wykonawczych

** Istnieje możliwość zamówienia produktu w pełnej kolorystyce Atlantic wg wzornika Gabriel w terminie nie krótszym niż 7 tygodni

*** Istnieje możliwość zamówienia produktu w pełnej kolorystyce Silvertex wg wzornika Spradling w terminie nie krótszym niż 15 dni roboczych

**** Istnieje możliwość zamówienia produktu w pełnej kolorystyce Charles wg wzornika Dekoma w standardowym terminie realizacji.

| Materiał | Kolor | Panele wolnostojące | | | | | | | | | | | | | | |
|----------|----------------------------------|---------------------|-----------|--------------|--|--|--|--|--|--|--|--|--|--|--|--|
| | | A - Panel | B - Stopa | C - Łączniki | | | | | | | | | | | | |
| Metal | M009 - aluminium półmat RAL 9006 | | ✓ | ✓ | | | | | | | | | | | | |
| | M015 - biały półmat RAL 9010 | | ✓ | | | | | | | | | | | | | |
| | M115 - czarny półmat RAL 9005 | | ✓ | | | | | | | | | | | | | |
| | M154 - antracyt półmat RAL 7043 | | ✓ | | | | | | | | | | | | | |

Panele wolnostojące

- 1 **Panel** - klasa akustyczności "A", tapicerowany; możliwość wpinania szpilek
- 2 **Zamek błyskawiczny** - ozdobny, bez możliwości odpinania, kolor: grafit
- 3 **Rama** - konstrukcja z litego drewna klejonego
- 4 **Wypełnienie** - włóknina akustyczna o wysokim stopniu pochłaniania i rozpraszania dźwięków
- 5 **Stopa wolnostojąca** - metal malowany proszkowo
- 6 **Stopka dystansowa** - metal malowany proszkowo; do zastosowania wyłącznie w panelach ustawianych pomiędzy biurkami, lub z innym stabilnym podparciem z obu stron
- 7 **Kółka z hamulcem** - Ø65 mm
- 8 **Tablica magnetyczna** - suchościernalna

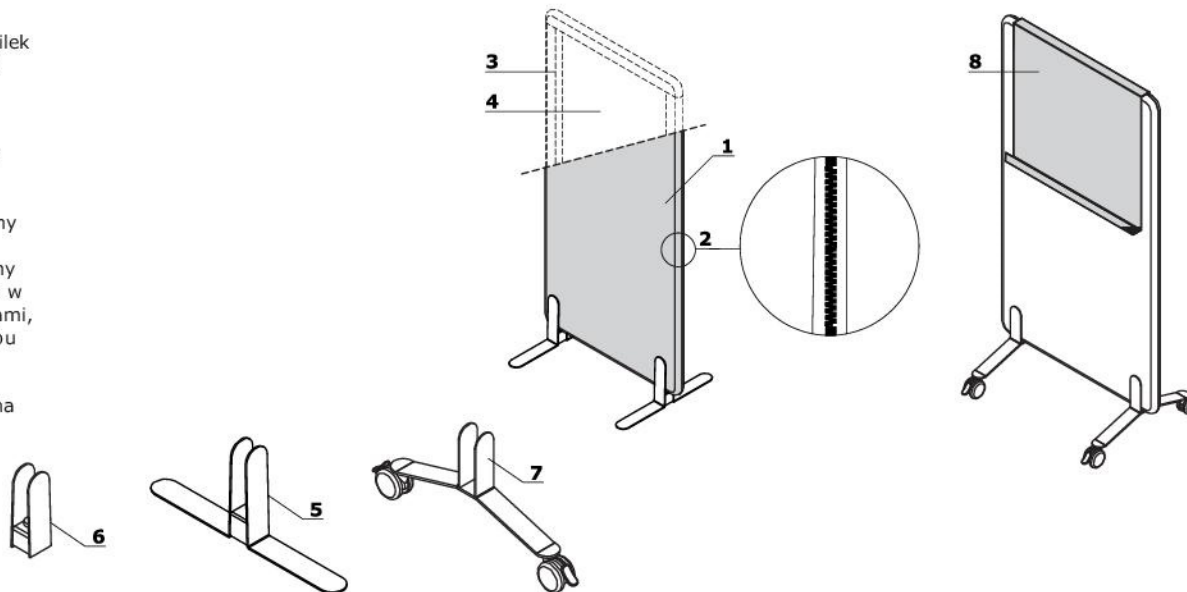

Łączniki do paneli wolnostojących Sonic

- 1 **Łącznik** - metal malowany proszkowo

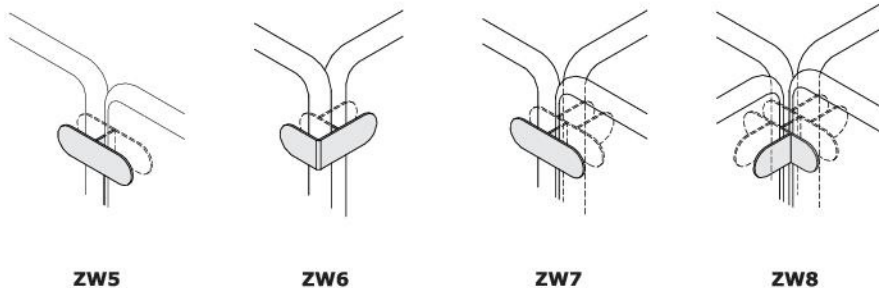

Wymiary (mm)

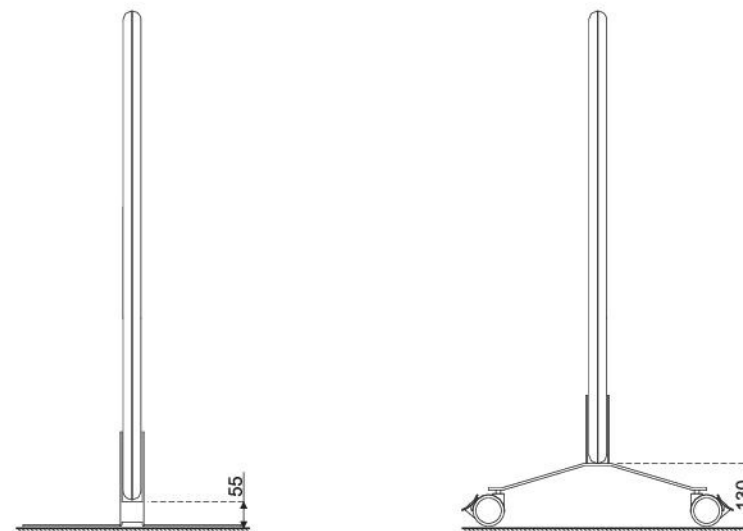

Zestawienie kolorystyczne - Viva - panel wolnostojący

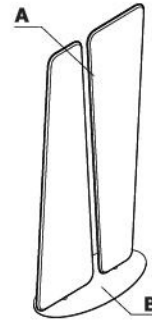

| Materiał | Kolor | Panel wolnostojący | | | | | | | | | | | | | | | | |
|----------|---------------------|--------------------|------------|--|--|--|--|--|--|--|--|--|--|--|--|--|--|--|
| | | A - Panel | B - Stelaz | | | | | | | | | | | | | | | |
| Tkanina | Nemo | ✓ | | | | | | | | | | | | | | | | |
| | Runner | II grupa ✓ | | | | | | | | | | | | | | | | |
| | Medley | II grupa ✓ | | | | | | | | | | | | | | | | |
| | **Atlantic | II grupa ✓ | | | | | | | | | | | | | | | | |
| | Vita | II grupa ✓ | | | | | | | | | | | | | | | | |
| | Mica | II grupa ✓ | | | | | | | | | | | | | | | | |
| | Go Check | II grupa ✓ | | | | | | | | | | | | | | | | |
| | ****Charles | II grupa ✓ | | | | | | | | | | | | | | | | |
| | *Tkanina powierzona | II grupa ✓ | | | | | | | | | | | | | | | | |
| | Synergy | III grupa ✓ | | | | | | | | | | | | | | | | |
| | ***Silvertex | III grupa ✓ | | | | | | | | | | | | | | | | |
| | Tessa | III grupa ✓ | | | | | | | | | | | | | | | | |
| | Oceanic | III grupa ✓ | | | | | | | | | | | | | | | | |
| | Quest | III grupa ✓ | | | | | | | | | | | | | | | | |
| | Grain | III grupa ✓ | | | | | | | | | | | | | | | | |
| | Atlas | IV grupa ✓ | | | | | | | | | | | | | | | | |

* Zastosowanie tkaniny powierzonej wymaga przeprowadzenia prób tapicerskich, w celu sprawdzenia możliwości wykonawczych

** Istnieje możliwość zamówienia produktu w pełnej kolorystyce Atlantic wg wzornika Gabriel w terminie nie krótszym niż 7 tygodni

*** Istnieje możliwość zamówienia produktu w pełnej kolorystyce Silvertex wg wzornika Spradling w terminie nie krótszym niż 15 dni roboczych

**** Istnieje możliwość zamówienia produktu w pełnej kolorystyce Charles wg wzornika Dekoma w standardowym terminie realizacji.

| Materiał | Kolor | Panel wolnostojący | | | | | | | | | | | | | |
|----------|----------------------------------|--------------------|------------|--|--|--|--|--|--|--|--|--|--|--|--|
| | | A - Panel | B - Stelaż | | | | | | | | | | | | |
| Metal | M009 - aluminium półmat RAL 9006 | | ✓ | | | | | | | | | | | | |
| | M015 - biały półmat RAL 9010 | | ✓ | | | | | | | | | | | | |
| | M115 - czarny półmat RAL 9005 | | ✓ | | | | | | | | | | | | |
| | M154 - antracyt półmat RAL 7043 | | ✓ | | | | | | | | | | | | |

Panel wolnostojący

- Panel** - tapicerowany, konstrukcja wykonana w technologii paneli Sonic, posiadających certyfikat akustyczności klasy A, możliwość wpinania szpilek
- Zamek błyskawiczny** - ozdobny, bez możliwości odpinania, kolor: grafit
- Rama** - rura stalowa
- Wypełnienie** - włóknina akustyczna o wysokim stopniu pochłaniania i rozpraszania dźwięków
- Stopa metalowa** - metal malowany proszkowo
- Obrót 360°** - każdy z paneli obraca się niezależnie

Wymiary (mm)











| Panel wolnostojący | | | | | | | |
|--------------------|-------------|--|---------|-----|------|---|-------|
| | Symbol | | Wymiary | | | Waga Obj. Opak. | Uwagi |
| | | | Szer. | Gł. | Wys. | | |
| | VV02 | | 850 | 400 | 1670 | 21.3 kg 0.084 m ³ 3 szt. | |

| | | | | | | | |
|--|--|--|--|--|--|--|--|
| | | | | | | | |
| | | | | | | | |









Metal

| | | | |
|--|--|---|--|
|  M009 - aluminium półmat RAL 9006 |  M015 - biały półmat RAL 9010 |  M115 - czarny półmat RAL 9005 |  M154 - antracyt półmat RAL 7043 |
|--|--|---|--|

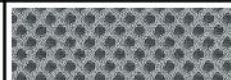
Tkanina Nemo - I grupa cenowa

| | | | | | | | |
|---|--|--|---|---|--|--|--|
|  NE-1 - beżowy |  NE-2 - żółty |  NE-3 - pomarańczowy |  NE-5 - czerwony |  NE-9 - zielony |  NE-10 - szary |  NE-14 - grafitowy |  NE-15 - granatowy |
|  NE-16 - czarny |  NE-17 - niebieski | | | | | | |











Tkanina Runner - II grupa cenowa

| | | | | | | | |
|---|---|--|---|--|--|---|--|
|  R-63034 - pomarańczowy |  R-64089 - czerwony |  R-66063 - niebieski |  R-60011 - szary |  R-68056 - zielony |  R-66064 - granatowy |  R-60999 - czarny |  R-60025 - grafitowy |
|  R-61128 - beżowy |  R-68110 - Ciemny zielony | | | | | | |

Tkanina Medley - II grupa cenowa

| | | | | | | | |
|---|---|--|---|---|--|---|---|
|  M-66008 - szary |  M-60003 - jasny szary |  M-61189 - beżowy |  M-68005 - ciemny oliwkowy |  M-62002 - żółty |  M-62054 - musztardowy |  M-63017 - rdzawy |  M-64019 - czerwony |
|  M-63064 - różowy |  M-65011 - szarofioletowy |  M-66010 - niebieski |  M-67006 - jasny niebieski |  M-60999 - czarny | | | |

Tkanina Atlantic - II grupa cenowa (Pozostałe kolory Atlantic wg wzornika Gabriel dostępne w terminie nie krótszym niż 7 dni roboczych)

| | | | | | | | |
|---|--|--|---|--|--|---|---|
|  A-67043 - ciemny turkusowy |  A-67030 - morski |  A-60141 - jasny szary |  A-60011 - szary |  A-66064 - granatowy |  A-65037 - fioletowy |  A-62048 - oliwkowy |  A-64089 - czerwony |
|  A-61078 - beżowy |  A-60025 - grafitowy | | | | | | |

Tkanina Vita - II grupa cenowa

| | | | | | | | |
|---|--|---|---|---|--|--|--|
|  V-01 - jasny szary |  V-02 - beżowy |  V-03 - żółty |  V-04 - szary |  V-07 - ciemny szary |  V-09 - oliwkowy |  V-10 - szarobrązowy |  V-11 - rdzawy |
|  V-12 - czarny |  V-39 - czekoladowy |  V-18 - morski |  V-19 - niebieski |  V-29 - ciemny zielony |  V-44 - beżowy |  V-46 - brązowy | |



Tkanina Go check - II grupa cenowa

| | | | | | | | |
|--|--|---|---|---|---|--|--|
|  G-66136 - niebieski |  G-66135 - jasny niebieski |  G-60080 - ciemny szary |  G-66138 - granatowy |  G-60084 - ciemny grafitowy |  G-68149 - ciemny zielony |  G-68152 - zielony |  G-60079 - szary |
|  G-64183 - marsala |  G-63079 - pomarańczowy |  G-64171 - czerwony |  G-64172 - bordowy |  G-61144 - brązowy |  G-61145 - ciemny brązowy | | |

Tkanina Charles - II grupa cenowa (Istnieje możliwość zamówienia produktu w pełnej kolorystyce Charles wg wzornika Dekoma w standardowym terminie realizacji.)

| | | | | | | | |
|--|---|--|---|---|--|--|---|
|  C-01 - czarny |  C-05 - szary |  C-06 - beżowy |  C-14 - brązowy |  C-18 - rdzawy |  C-21 - czerwony |  C-30 - różowy |  C-31 - marsala |
|  C-32 - niebieski ciemny |  C-35 - niebieski |  C-41 - żółty |  C-44 - oliwkowy |  C-45 - zielony | | | |

Tkanina Mica - II grupa cenowa

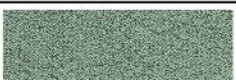
| | | | | | | | |
|--|---|--|---|--|--|--|--|
|  MC-01 - różowy |  MC-02 - czerwony |  MC-03 - ciemny czerwony |  MC-04 - granatowy |  MC-05 - niebieski |  MC-06 - morski |  MC-07 - zielony butelkowy |  MC-08 - zielony |
|  MC-09 - oliwkowy |  MC-10 - jasny oliwkowy |  MC-11 - musztardowy |  MC-12 - żółty |  MC-13 - beżowy |  MC-14 - jasny szary |  MC-15 - szary |  MC-16 - grafitowy |
|  MC-17 - niebieski jasny |  MC-18 - miętowy |  MC-19 - bordowy | | | | | |











Tkanina Synergy - III grupa cenowa

| | | | | | | | |
|--|---|---|---|--|---|---|--|
|  LDS08 - szary melanz |  LDS20 - jasny szary |  LDS27 - czarny |  LDS29 - ciemny szary |  LDS50 - ciemny zielony |  LDS57 - turkusowy |  LDS60 - zielony butelkowy |  LDS61 - śliwkowy |
|  LDS69 - granatowy |  LDS84 - pomarańczowy |  LDS86 - czerwony |  LDS88 - oberżyna |  LDS19 - beżowy |  LDS44 - żółty |  LDS79 - brązowy | |

Tkanina Tessa - III grupa cenowa

| | | | | |
|---|--|---|---|---|
|  T-08 - kremowy |  T-09 - beżowy |  T-05 - szary |  T-03 - ciemny szary |  T-02 - grafitowy |
|---|--|---|---|---|

Tkanina Oceanic - III grupa cenowa

| | | | | | | | |
|--|--|--|--|---|---|---|---|
|  O-16 - różowy |  O-05 - koralowy |  O-12 - czerwony |  O-07 - żółty |  O-04 - jasny zielony |  O-15 - jasny niebieski |  O-11 - niebieski |  O-13 - jasny szary |
|  O-08 - ciemny szary |  O-01 - czarny | | | | | | |

Tkanina Quest - III grupa cenowa

| | | | | | | | |
|---|--|--|--|--|--|---|---|
|  Q-26 - różowy |  Q-25 - pomarańczowy |  Q-24 - czerwony |  Q-21 - pastelowy żółty |  Q-19 - beżowy |  Q-18 - oliwkowy |  Q-13 - jasny zielony |  Q-07 - jasny niebieski |
|  Q-08 - granatowy |  Q-04 - grafitowy | | | | | | |

Tkanina Silvertex - III grupa cenowa - Istnieje możliwość zamówienia produktu w pełnej kolorystyce Silvertex wg wzornika Spradling w terminie nie krótszym niż 15 dni roboczych.

Tkanina Grain - III grupa cenowa

| | | | | | | | |
|--|---|--|---|--|--|---|---|
|  GR-64249 - różowy |  GR-62122 - żółty |  GR-62016 - jasny pomarańczowy |  GR-63117 - pomarańczowy |  GR-68243 - oliwkowy |  GR-66236 - błękitny |  GR-66232 - granatowy |  GR-60301 - szary |
|  GR-61252 - beżowy |  GR-61250 - biały | | | | | | |

Tkanina Atlas - IV grupa cenowa

| | | | | | | | |
|---|--|--|--|---|---|--|---|
|  AS-531 - pomarańczowy |  AS-501 - różowy |  AS-651 - czerwony |  AS-681 - bordowy |  AS-391 - brązowy |  AS-781 - granatowy |  AS-161 - ciemny szary |  AS-111 - jasny szary |
|  AS-971 - jasny zielony |  AS-981 - ciemny zielony | | | | | | |