

.mdd

Pracowniczy
v13.2022

Zestawienie kolorystyczne - Ogi

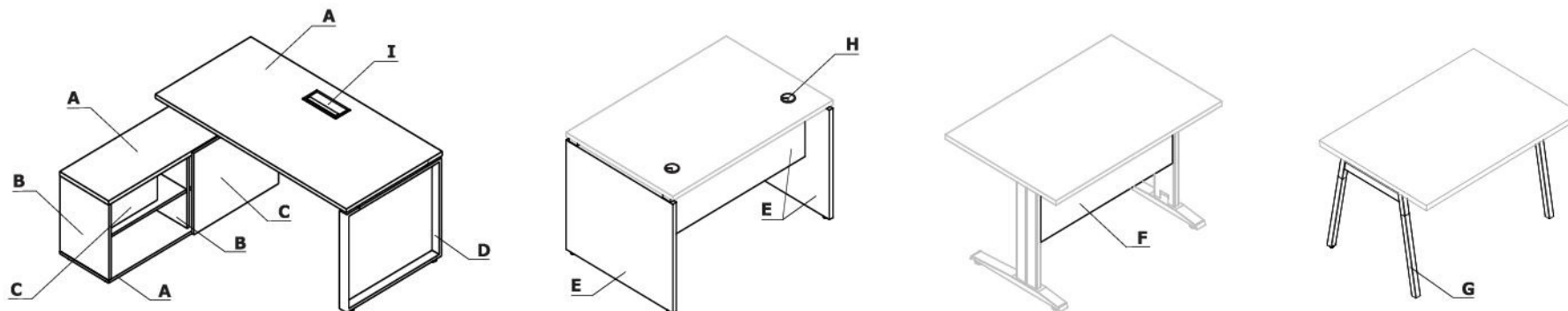

Materiał	Kolor	Biaurka								Akcesoria					
		A - Blat, wieniec górny i dolny	B - Korpus	C - Front	D - Stelaż	E - Podstawa Ogi V	F - Osłona płytowa Ogi N	G - Podstawa Ogi W	H - Przepusty kablowe	I - Mediabox	SOD12-SOD20, SG12, SG16, SG220, SG260	E64, S69	S94, S95, S81, S82	S83, S89, S93	S11
Płyta	26 - aluminium satynato	✓*	✓	✓		✓									
	31 - dąb kanadyjski	✓	II grupa	✓											
	39 - brzoza polarna	✓	II grupa	✓											
	64 - kakao	✓	II grupa	✓											
	67 - biały pastel	✓*	✓	✓		✓									
	106 - orzech nizinny	✓	II grupa	✓											
	154 - antracyt	✓*	✓	✓		✓									
	08 - czarny	✓*	✓	✓		✓									
	167 - dąb szary	✓	II grupa	✓											
	168 - dąb naturalny	✓	II grupa	✓											
	169 - dąb miodowy	✓	II grupa	✓											
	170 - akacja	✓	II grupa	✓											
	171 - orzech ciemny	✓	II grupa	✓											

* UWAGA - Ogi W - OPCJA Z DOPLATĄ - obrzeże blatu, kolor: jesion naturalny

Materiał	Kolor	Biuurka									Akcesoria				
		A - Biał, wieniec górny i dolny	B - Korpus	C - Front	D - Stelaż	E - Podstawa Ogi V	F - Osłona płytowa Ogi N	G - Podstawa Ogi W	H - Przepusty kablowe	I - Media box	SOD12-SOD20, SG12, SG16, SG220, SG260	E64, S69	S94, S95, S81, S82	S83, S89, S93	S11
Tworzywo	02 - szary								✓						
	08 - czarny								✓						
	24 - beżowy								✓						
	67 - biały pastel								✓						
	Jesion naturalny							✓**							
Metal	M009 - aluminium półmat RAL 9006				✓		26 - aluminium satinato			✓	✓	✓	✓	✓	✓
	M015 - biały półmat RAL 9010				✓		67 - biały pastel			✓	✓	✓	✓	✓	✓
	M154 - antracyt półmat RAL 7043				✓		154 - antracyt			✓					
	M115 - czarny półmat RAL 9005				✓		08 - czarny			✓	✓	✓	✓	✓	✓
	M026 - oliwkowy półmat RAL 6013				✓*										
	M027 - niebieski półmat RAL5003				✓*										
	M028 - ceglasty półmat RAL 0404040				✓*										
	M029 - żółty półmat RAL 0807060				✓*										
	M030 - beżowy półmat RAL 0608005				✓*										

Stelaż

•**Ogi N** - metal malowany proszkowo,
kolumna 642x149x36 mm, stopa 647x60
mm, pionowe prowadzenie okablowania, łączyna -
płyta melaminowana 18 mm

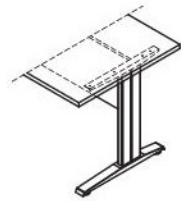
**Ogi N**

Akcesoria

- 1 Szyna S69 - metal malowany proszkowo
- 2 Szyna do pojedynczego biurka (SG12, SG16) - metal malowany proszkowo
- 3 Szyna E64 - metal malowany proszkowo
- 4 Szyna do bench Ogi Drive (SOD12, SOD14, SOD16, SOD18, SOD20) - metal malowany proszkowo
- 5 Szyna do biurka typu bench (SG220, SG260) - drut stalowy Ø4 mm, malowany proszkowo

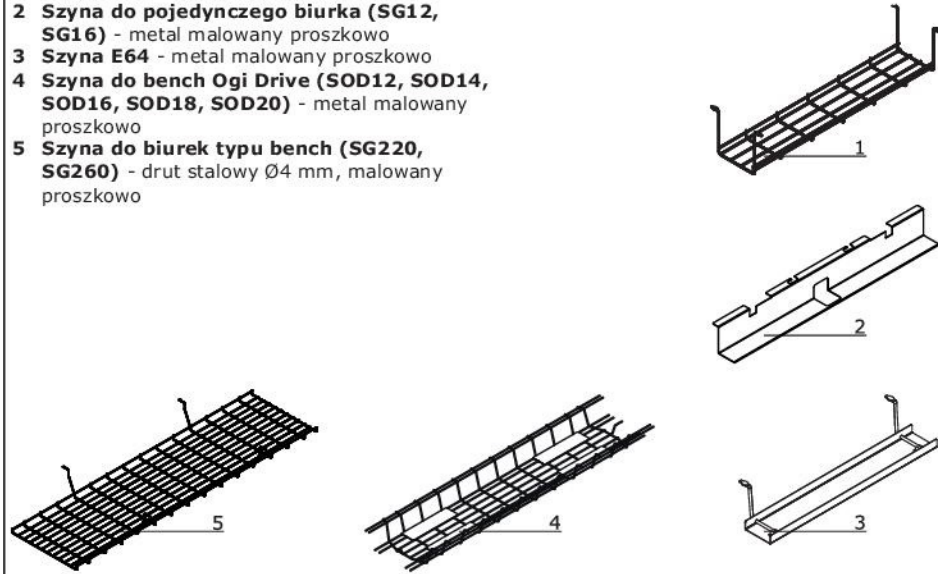

Listwa zasilająca - do łączenia w szereg

- 1 PWS1 - zestaw do 1 stanowiska - listwa zasilająca (3 x schuko, 2 RJ45) x 1 + przewód zasilający (wtyczka uniwersalna PL/FR/Schuko)
- 2 PWS2 - zestaw do 2 stanowisk - listwa zasilająca (3 x schuko, 2 RJ45) x 2 + komplet przewodów zasilających (wtyczka uniwersalna PL/FR/Schuko)
- 3 PWS3 - zestaw do 3 stanowisk - listwa zasilająca (3 x schuko, 2 RJ45) x 3 + komplet przewodów zasilających (wtyczka uniwersalna PL/FR/Schuko)

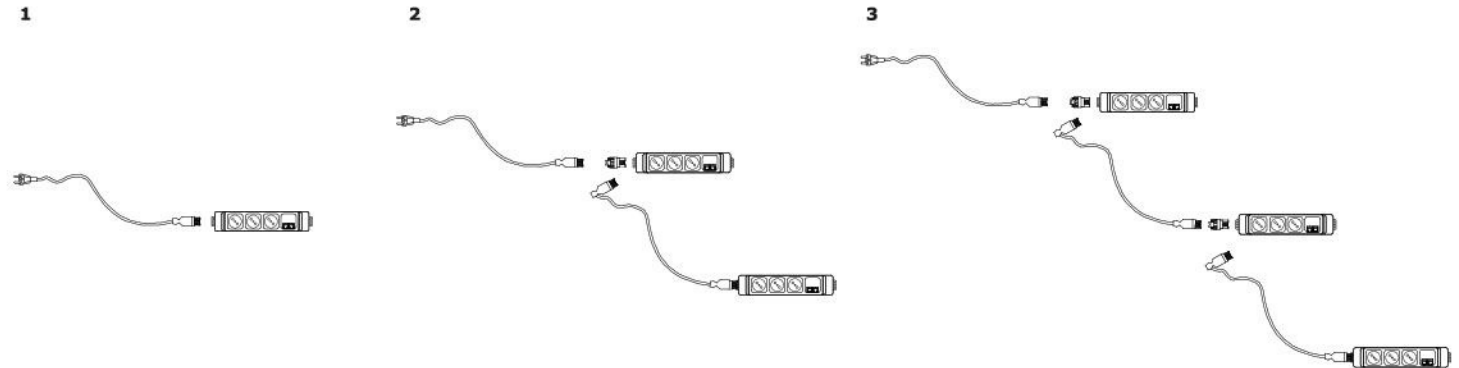

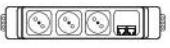







Akcesoria							
	Symbol		Wymiary			Waga Obj. Opak.	Uwagi
			Szer.	Gł.	Wys.		
	PWS1		300	60	45	1.1 kg 0.005 m3 1 szt.	
	PWS2		300	60	45	1.6 kg 0.005 m3 1 szt.	
	PWS3		300	60	45	2.1 kg 0.005 m3 1 szt.	

Płyta

 08 - czarny	 26 - aluminium satinato	 31 - dąb kanadyjski	 39 - brzoza polarna	 64 - kakao	 67 - biały pastel	 106 - orzech nizinny	 154 - antracyt
 167 - dąb szary	 168 - dąb naturalny	 169 - dąb miodowy	 170 - akacja	 171 - orzech ciemny			

Metal

 M009 - aluminium półmat RAL 9006	 M015 - biały półmat RAL 9010	 M115 - czarny półmat RAL 9005	 M154 - antracyt półmat RAL 7043	 M026 - oliwkowy półmat RAL 6013	 M027 - niebieski półmat RAL5003	 M028 - ceglasty półmat RAL 040404	 M029 - żółty półmat RAL 0807060
 M030 - beżowy półmat RAL 0608005							

Tworzywo/poliuretan/polipropylen

 Biały pastel	 Czarny	 Szary	 Beżowy
---	---	--	--