

.mdd

Stoliki i stoły konferencyjne
v5 / 01.05.2023

Zestawienie kolorystyczne - New School

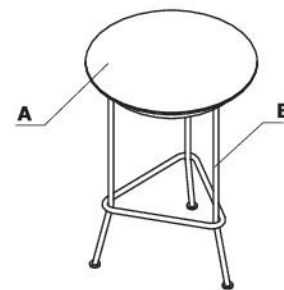

Materiał	Kolor	Stoly i stoliki												
		A - Blat	B - Stelaz											
Linoleum	Jasny szary	✓												
	Ciemny zielony	✓												
	Bordowy	✓												
	Czarny	✓												
	Niebieski	✓												
Metal	M010 - jasny szary półmat RAL 7044		✓											
	M012 - ciemny zielony półmat RAL 6012		✓											
	M013 - bordowy półmat RAL 3007		✓											
	M115 - czarny półmat RAL 9005		✓											
	M027 - niebieski półmat RAL5003		✓											





* UWAGA - Obrzeże blatu zawsze w kolorze stelaża.

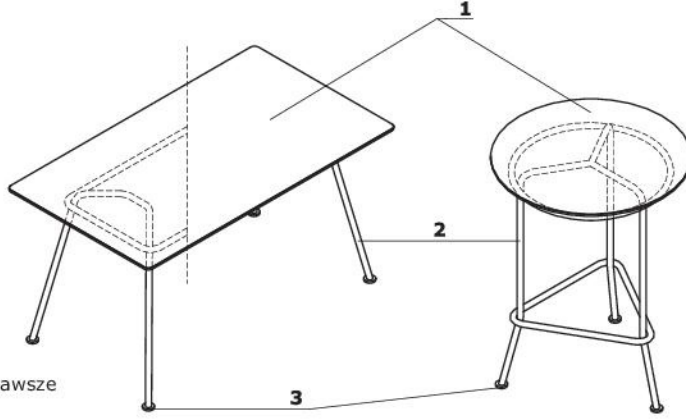



Stoły i stoliki

- 1 Blat** - płyta MDF 19 mm; pokryty bakteriostatycznym linoleum odpornym na odciski palców; obrzeże lakierowane
- 2 Noga** - metal malowany proszkowo, wykonany z rury \varnothing 25 mm
- 3 Stopki** - regulacja poziomu w zakresie 9 mm



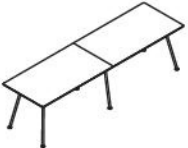

UWAGA - Obrzeże blatu zawsze w kolorze stelaża.

Stoły i stoliki							
	Symbol		Wymiary			Waga Obj. Opak.	Uwagi
			Szer.	Gł.	Wys.		
	NS812		1200	800	750	33.1 kg 0.395 m ³ 4 szt.	
	NS814		1400	800	750	33.5 kg 0.402 m ³ 4 szt.	
	NS816		1600	800	750	36.6 kg 0.41 m ³ 4 szt.	
	NS818		1800	800	750	40.3 kg 0.417 m ³ 4 szt.	
	NS77		700	700	750	19.8 kg 0.352 m ³ 4 szt.	
	NS88		800	800	750	25.3 kg 0.381 m ³ 4 szt.	
	NS11		1000	1000	750	31 kg 0.421 m ³ 4 szt.	
	NS70		700	700	750	15.5 kg 0.398 m ³ 2 szt.	
	NS80		800	800	750	17 kg 0.404 m ³ 2 szt.	
	NS100		1000	1000	750	26.5 kg 0.396 m ³ 4 szt.	

Stoły wysokie							
	Symbol		Wymiary			Waga Obj. Opak.	Uwagi
			Szer.	Gł.	Wys.		
	NS80H		800	800	1050	22 kg 0.585 m ³ 2 szt.	
	NS100H		1000	1000	1050	31.7 kg 0.483 m ³ 5 szt.	
	NS88H		800	800	1050	30.5 kg 0.468 m ³ 5 szt.	
	NS11H		1000	1000	1050	37.5 kg 0.57 m ³ 5 szt.	
	NS812H		1200	800	1050	39.5 kg 0.484 m ³ 5 szt.	
	NS814H		1400	800	1050	40.5 kg 0.492 m ³ 5 szt.	
	NS816H		1600	800	1050	43.8 kg 0.499 m ³ 5 szt.	
Stoły konferencyjne							
	NS824		2400	800	750	61.9 kg 0.615 m ³ 7 szt.	
	NS828		2800	800	750	62.3 kg 0.63 m ³ 7 szt.	
	NS832		3200	800	750	69.1 kg 0.644 m ³ 7 szt.	
	NS836		3600	800	750	76.1 kg 0.658 m ³ 7 szt.	

Linoleum

				
Jasny szary	Ciemny zielony	Bordowy	Czarny	Niebieski

Metal

				
M010 - jasny szary półmat RAL 7044	M012 - ciemny zielony półmat RAL 6012	M013 - bordowy półmat RAL 3007	M115 - czarny półmat RAL 9005	M027 - niebieski półmat RAL5003