

Folding tables - Plica technical specification



.mdd

.mdd has a leading position among manufacturers of office furniture with many awards that prove quality and continuously increase demand for it's products.

The realities of today`s market require constant quality improvement at all levels of modern organization. This applies in particular to customer service, marketing, quality of products and also to quality of processes within the company.

Partnership relations among employees and with business partners form a base of economic growth and success of the company.

Constant investments in innovative machinery park, optimization of management systems and an expansion of production halls allow to minimize the lead times for the product of the highest quality.

More than twenty years of experience in office furniture industry come with reference from a long list of companies and institutions to show their appreciation for an efficient and comprehensive service. .mdd is highly aware of the environment.

Being located in the forest region with lake by it's side, .mdd takes the nature seriously and invests constantly in a modern and energy-efficient solutions to preserve the local life. Company puts emphasis on waste segregation and recycling. .mdd has been awarded for the exceptional care and involvement in waste disposal. All materials used are environmentally friendly and enjoy a high 95 % rate of being recycled.



General informations:

Warranty:

.mdd products - **5 years.**

Electrical components and fabric - **2 years.**

Certificate - MFC:



Boards density:

12 mm - 690 - 750 kg/m³

18 mm - 650 - 690 kg/m³

28 mm - 610 - 630 kg/m³

36 mm - 610 - 630 kg/m³

Assembly:

product delivered in separate elements

Packing:

cartboard

Plica - folding tables

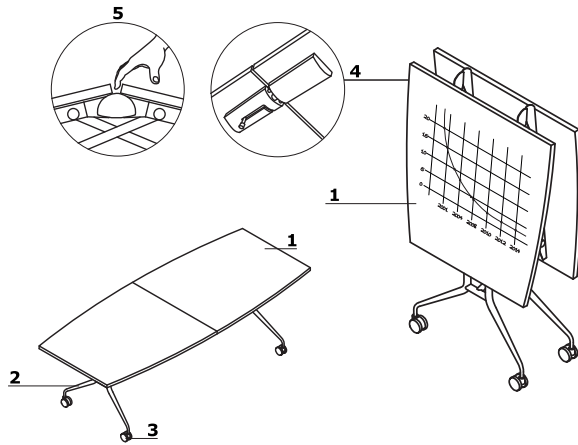

1. **Worktop** - MFC 28 mm, ABS edge

OPTIONS WITH EXTRA CHARGE:

* worktop covered in nano - tech laminate FENIX, colour: black, 30mm worktop thickness; ABS edges, colour: black or with an additional fee - natural ash option

* "dry - wipe board", colour: white; 27mm worktop thickness

2. **Leg** - powder coated steel, colour: white, black, aluminium or with an additional fee - chrome option

3. **Wheels with brake** - Ø100 mm

4. **Blocking bolt** - protecting against accidental folding

5. Protection mechanism against hand jamming during folding and unfolding of the table

Folding tables *

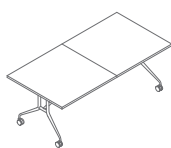

PCP01
2000 / 1000 / 740**
79.2 kg

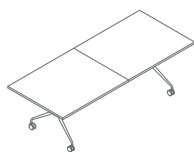

PCP02
2400 / 1000 / 740**
88.5 kg

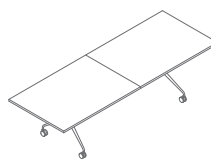

PCP03
2800 / 1000 / 740**
95.6 kg

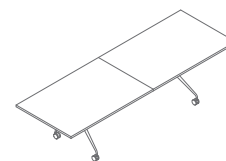

PCP04
3000 / 1000 / 740**
97 kg

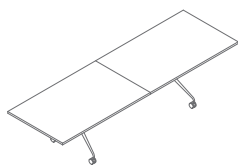

PCP05
3200 / 1000 / 740**
101 kg

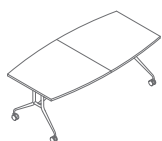

PCB01
2000 / 1000 / 740**
76.7 kg

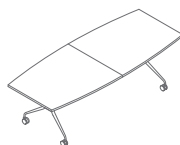

PCB02
2400 / 1000 / 740**
86 kg

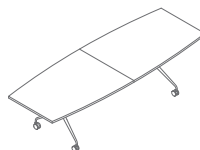

PCB03
2800 / 1000 / 740**
94 kg

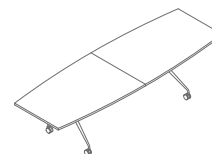

PCB04
3000 / 1000 / 740**
97 kg

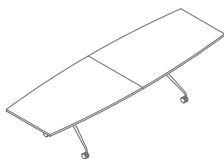

PCB05
3200 / 1000 / 740**
101 kg

* dimensions expressed in millimeters: width x depth x height
** height depends on the selected type of worktop

Folding tables *

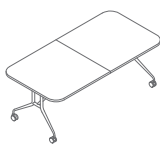

PCZ01
2000 / 1000 / 740**
79 kg

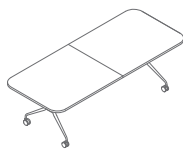

PCZ02
2400 / 1000 / 740**
86 kg

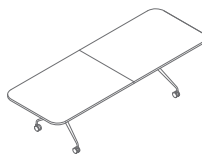

PCZ03
2800 / 1000 / 740**
94 kg

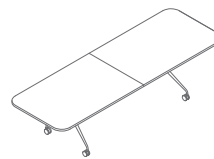

PCZ04
3000 / 1000 / 740**
97 kg

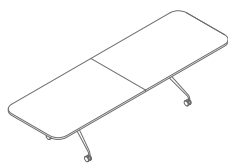

PCZ05
3200 / 1000 / 740**
101 kg

* dimensions expressed in millimeters: width x depth x height
** height depends on the selected type of worktop

Folding tables Plica	Date of preparation 17.12.2021	The data contained in this document is valid in the day of its preparation. Change of the product, as long as it does not affect the basic features of it, does not require consistent updates of the document.	page 5/6
			products

Top



Frame

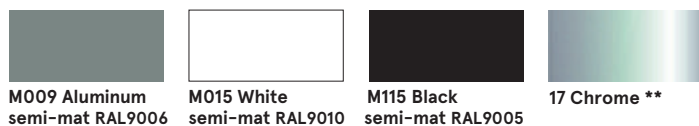

* option with an upcharge: worktop laminated in HPL FENIX - edges in either 08 - black or 160 - ash (with an upcharge)
 ** option with an upcharge