

# Folding tables Easy technical specification



.mdd

**.mdd has a leading position among manufacturers of office furniture with many awards that prove quality and continuously increase demand for it's products.**

The realities of today`s market require constant quality improvement at all levels of modern organization. This applies in particular to customer service, marketing, quality of products and also to quality of processes within the company.

Partnership relations among employees and with business partners form a base of economic growth and success of the company.

Constant investments in innovative machinery park, optimization of management systems and an expansion of production halls allow to minimize the lead times for the product of the highest quality.

**More than twenty years of experience in office furniture industry come with reference from a long list of companies and institutions to show their appreciation for an efficient and comprehensive service. .mdd is highly aware of the environment.**

Being located in the forest region with lake by it's side, .mdd takes the nature seriously and invests constantly in a modern and energy-efficient solutions to preserve the local life. Company puts emphasis on waste segregation and recycling. .mdd has been awarded for the exceptional care and involvement in waste disposal. All materials used are environmentally friendly and enjoy a high 95 % rate of being recycled.



## General informations:

### Warranty:

.mdd products - **5 years.**

Electrical components and fabric - **2 years.**

### Certificate - MFC:



### Boards density:

12 mm - 690 - 750 kg/m<sup>3</sup>

18 mm - 650 - 690 kg/m<sup>3</sup>

28 mm - 610 - 630 kg/m<sup>3</sup>

36 mm - 610 - 630 kg/m<sup>3</sup>

### Assembly:

product delivered in separate elements

### Packing:

cartboard

Folding tables Easy

1. **Worktop** - MFC 28 mm, ABS edge
2. **Frame** - metal, powder coated, profile Ø22 mm
3. **Joining rail** - metal, powder coated, colour: M009 - aluminum semi-matt, profile 40x20 mm
4. **Wheels with brake** - Ø65 mm
5. **Optional modesty panel US92** - MFC 18 mm, ordered separately
6. **Hook** - to connect tables
7. **Release button**
8. **Folding base** - chrome
9. **OPTION WITH EXTRA CHARGE** - Mediabox + horizontal cable tray:
  - Mediabox M08H - 2xRJ45 (class E, cat. 6); +1 x USB + 1 x HDMI + 4x 230V, mediabox colour is matched to the colour of the frame
  - Mediabox M08 - 2xRJ45 (class E, cat. 6); +1 x USB + 4x 230V, mediabox colour is matched to the colour of the frame

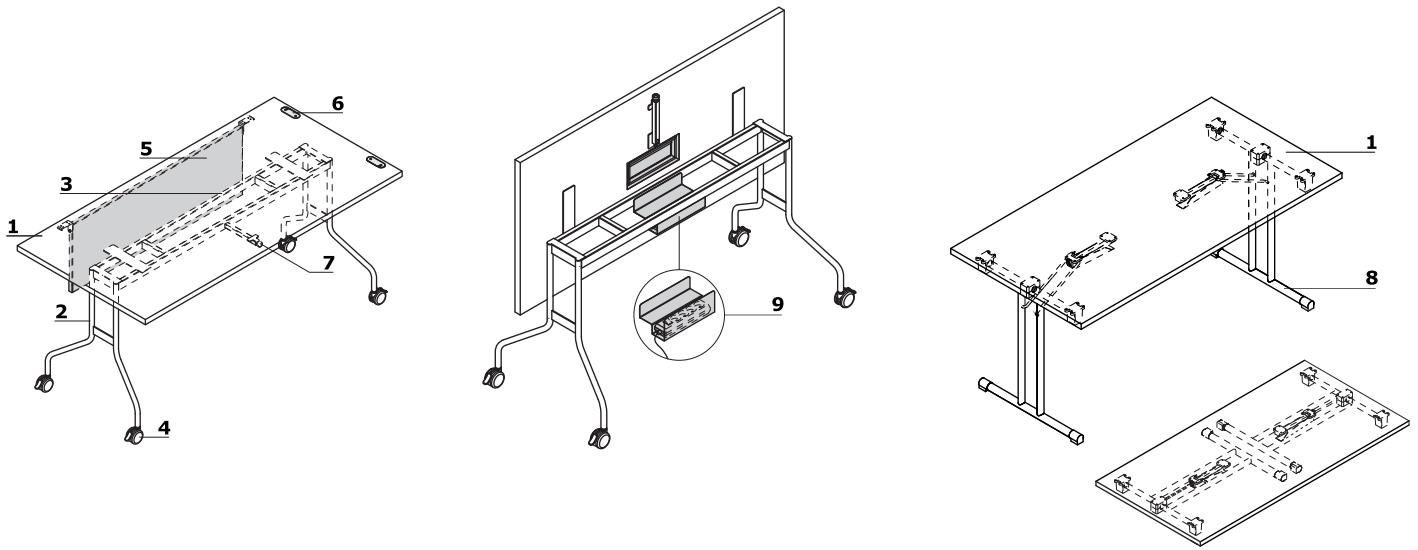

www.mdd.eu

Easy tables configurations

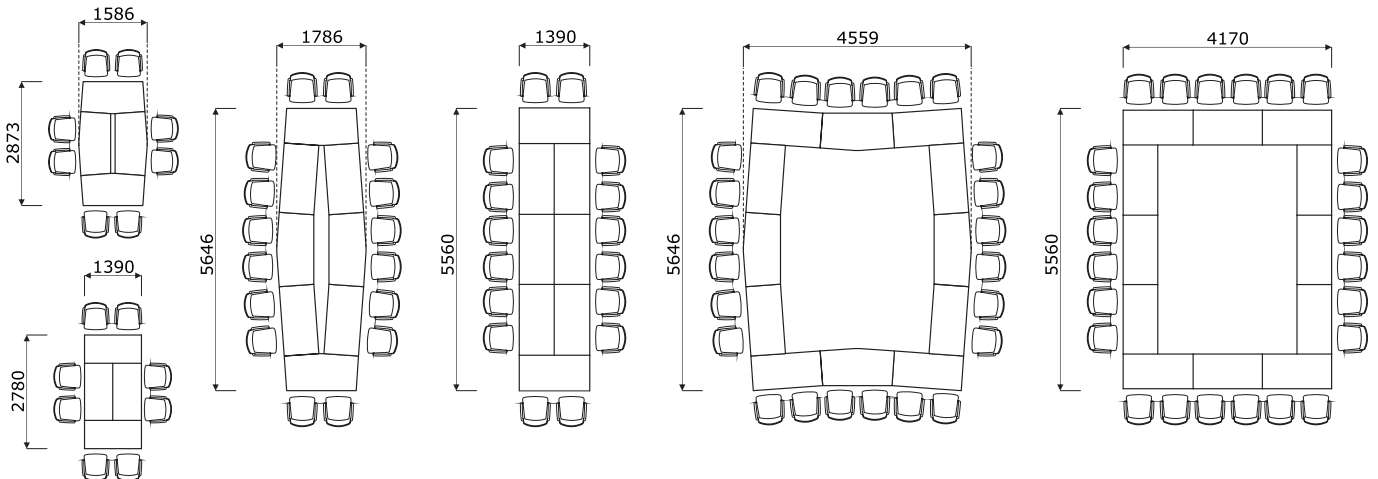

<p>Folding tables Easy</p>	<p>Date of preparation 17.12.2021</p>	<p>The data contained in this document is valid in the day of its preparation. Change of the product, as long as it does not affect the basic features of it, does not require consistent updates of the document.</p>	<p>page 3/6 technical specification</p>
----------------------------	-------------------------------------------	------------------------------------------------------------------------------------------------------------------------------------------------------------------------------------------------------------------------	---------------------------------------------

Chairs arrangement

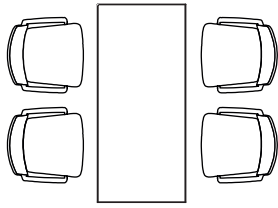

**PFT03**

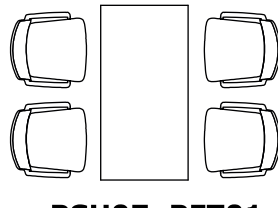

**PSU07, PFT01**

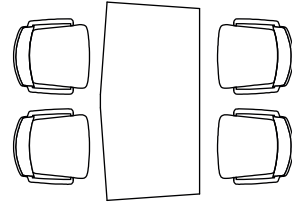

**PFT02**

Folding tables \*

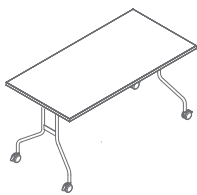

**PFT01**  
1390 / 695 / 740  
32.3 kg

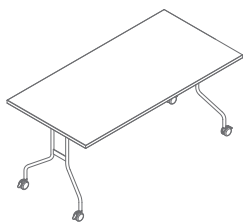

**PFT03**  
1600 / 800 / 740  
38.9 kg

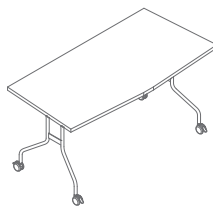

**PFT02**  
1486 / 743 / 740  
33 kg

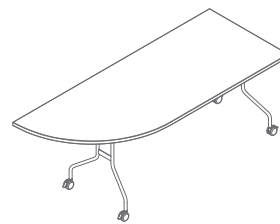

**PFT04**  
2000 / 800 / 740  
42.75 kg

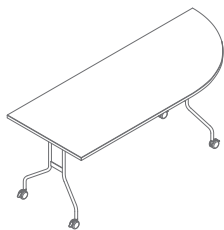

**PFT05**  
2000 / 800 / 740  
42.75 kg



**PFT06**  
695 / 1390 / 740  
267.4 kg

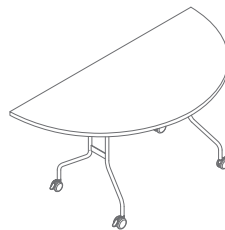

**PFT07**  
800 / 1600 / 740  
32.35 kg

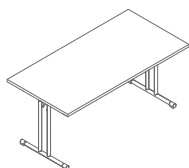

**PSU07**  
1390 / 695 / 725  
25 kg

MFC modesty screen \*



**US92**  
925 / 18 / 320  
4.4 kg

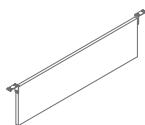

**US93**  
1135 / 18 / 320  
5.65 kg

\* dimensions expressed in millimeters: width x depth x height

### Top



08 Black



26 Aluminum  
satinato



31 Canadian oak

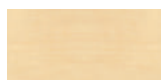

39 Polar birch



64 Cocoa



67 White pastel



106 Lowland  
walnut



154 Anthracite



167 Grey oak



168 Natural oak



169 Honey oak

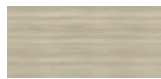

170 Acacia

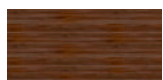

171 Dark walnut

### Frame, mediabox



M009 Aluminum  
semi-mat RAL9006



M015 White  
semi-mat RAL9010



M154 Anthracite  
semi-mat RAL7043



M115 Black  
semi-mat RAL9005

### Frame PSU07



17 Chrome