

flos collection



bejot:



**Tomasz
Augustyniak**

en:

Designer and interior architect, graduate of the Academy of Fine Arts in Poznań. Author of numerous collections of office and home furniture for major Polish brands. Winner of numerous design awards.

pl:

Projektant i architekt wnętrz, absolwent Akademii Sztuk Pięknych w Poznaniu. Autor wielu kolekcji mebli biurowych i domowych dla najważniejszych polskich marek. Laureat licznych nagród z dziedziny designu.

de:

Designer und Innenarchitekt, Absolvent der Akademie der Schönen Künste in Poznań. Autor zahlreicher Kollektionen von Büro- und Wohnmöbeln für große polnische Marken. Preisträger zahlreicher Designpreise.

The Flos furniture collection and multifunctional acoustic screens were designed with the idea of domesticating work and relaxation spaces.

be:cosy

be:comfortable

be:relaxed

be:homely

be:biophilic

bejot: of the world

:The starting point for me were two design directions, interdependent on each other:

form and ergonomics.

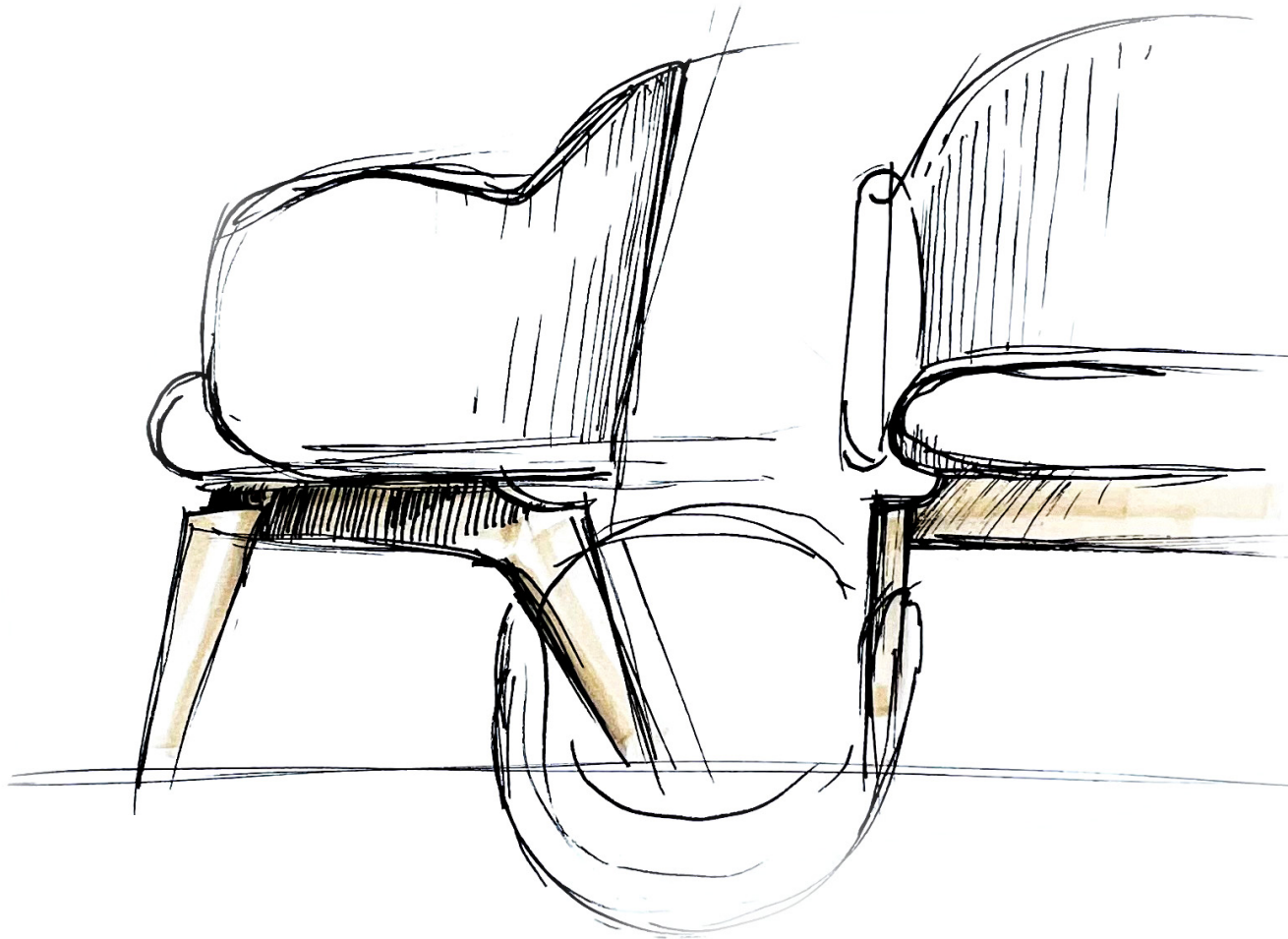

"I designed the Flos collection with domesticated work and leisure spaces in mind. My starting point was two design directions, interdependent: form and ergonomics.

The first - the search for a flowing shape line connecting all the elements of the collection, expressing peace, balance and harmony.

The second - to achieve maximum comfort in the furniture, while limiting the use of material.

In the acoustic walls, I was keen to enrich their functionality, so that both as individual pieces and as well as put together, they could perform additional 'meeting' and 'display' functions.

As a result, the fluid contour line of the furniture was inscribed into one of the sides of the walls and acoustic panels, opening up a wide range of possibilities for arrangement and composition".

**Tomasz Augustyniak
designer**





flos

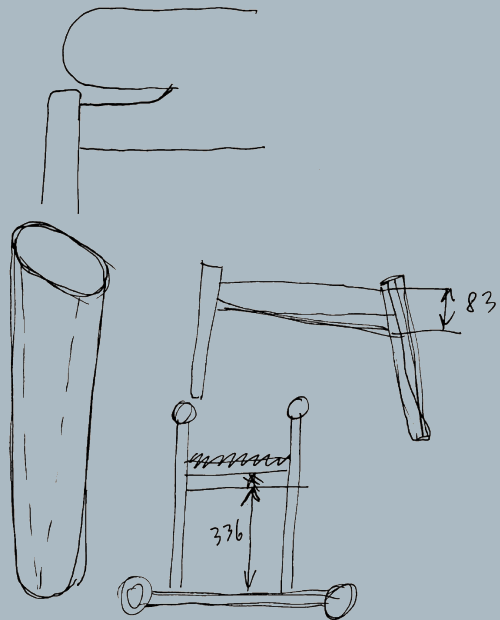
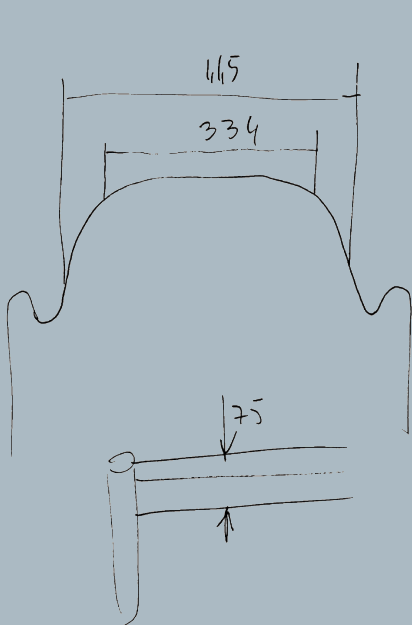
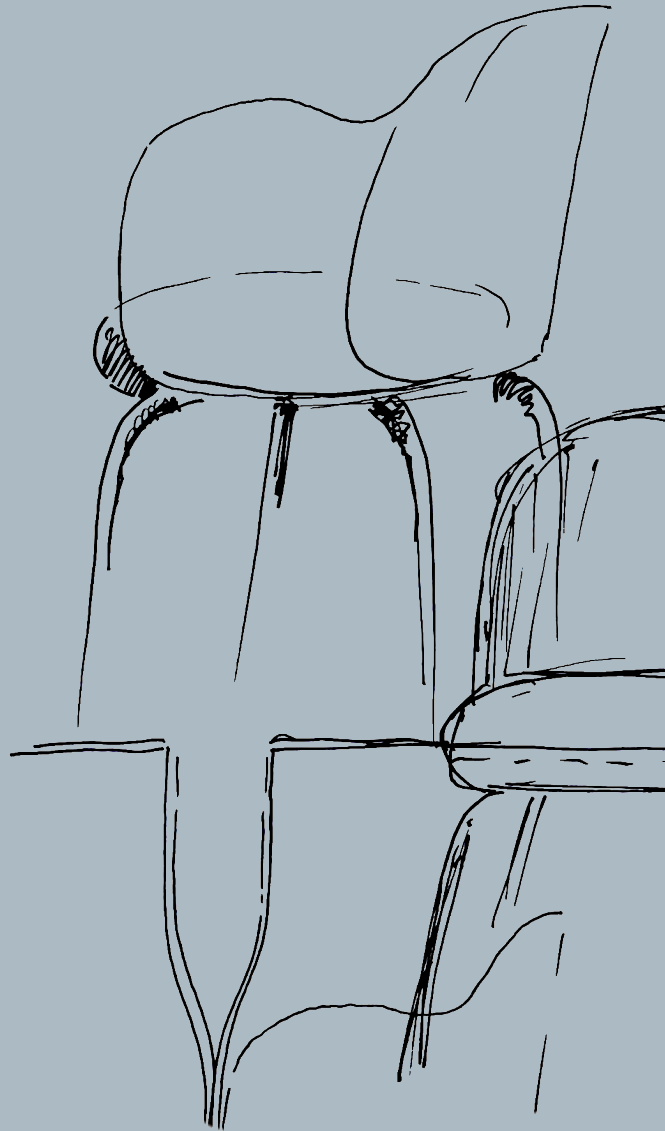
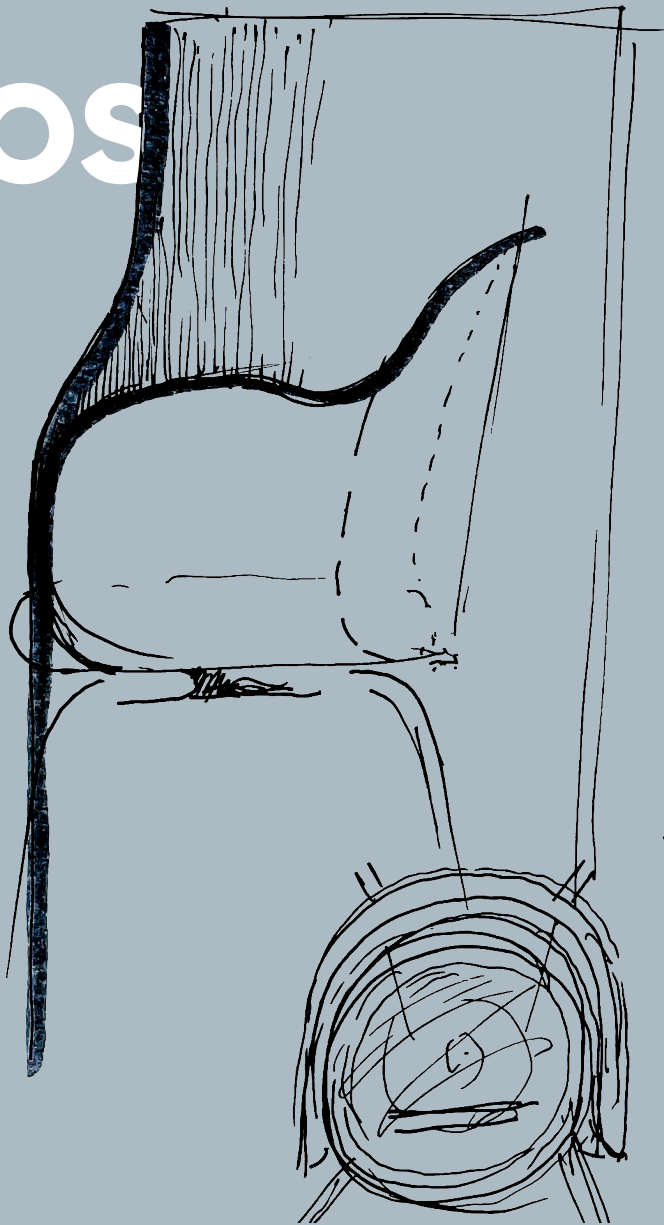



en:

Inspiration

Form and ergonomics are the determinants that have guided the process of creating Flos furniture from the very beginning.

While searching for the form, Tomasz Augustyniak focused on the flowing line of the shape, combining all the elements of the collection expressing peace, balance and harmony while achieving maximum comfort.

From the juxtaposition of these two concepts, and with a reduction in material use, our latest collection was created, containing diverse yet cohesive components linked by a distinctive wavy line based on floral motifs.

pl:

Inspiracja

Forma i ergonomia to wyznaczniki, które od samego początku kierowały proces tworzenia mebli Flos.

Podczas poszukiwania formy Tomasz Augustyniak skupił się na płynnej linii kształtu, łączącej wszystkie elementy kolekcji wyrażające spokój, równowagę i harmonię z jednoczesnym uzyskaniem maksymalnego komfortu. Z zestawienia tych dwóch koncepcji, a także przy ograniczeniu zużycia materiału powstała nasza najnowsza kolekcja zawierająca różnorodną, a jednocześnie spójną komponenty połączone charakterystyczną, falistą linią opartą o roślinne motywy.

de:

Inspiration

Form and Ergonomie sind die Determinanten, die den Entstehungsprozess der Flos-Möbel von Anfang an geleitet haben.

Auf der Suche nach der Form konzentrierte sich Tomasz Augustyniak auf eine fließende Formlinie, die alle Elemente der Kollektion miteinander verbindet und Ruhe, Gleichgewicht und Harmonie bei maximalem Komfort zum Ausdruck bringt.

Aus der Gegenüberstellung dieser beiden Konzepte und mit einer Reduzierung des Materialeinsatzes entstand unsere neueste Kollektion, die aus verschiedenen, aber dennoch kohärenten Komponenten besteht, die durch eine charakteristische Wellenlinie mit floralen Motiven verbunden sind.



FS KP 5R

Upholstered with Remix RX433
Metal finish RAL 9005 S



F SK 5R

Upholstered with Pastel PA153
Metal finish RAL 9005 S

en:

Conference chairs

A wide range of applications and a wide range of bases: metal, wooden or on castors. A single piece of furniture offers a multitude of configuration possibilities, making Flos perfect for a variety of settings. Two equally comfortable types of seating - with or without armrests - are the answer to the sophisticated needs of today's working environment.

pl:

Krzesła konferencyjne

Szeroka gama zastosowań i bogata oferta podstaw: metalowe, drewniane lub na kółkach. Jeden mebel daje wiele możliwości konfiguracji, dzięki czemu Flos znakomicie sprawdzi się w zróżnicowanych aranżacjach. Dwa równie komfortowe rodzaje siedzeń - z podłokietnikami lub bez - to odpowiedź na wysublimowane potrzeby dzisiejszego środowiska pracy.

de:

Konferenzstühle

Eine breite Palette von Anwendungen und eine breite Palette von Gestellen: Metall, Holz oder auf Rollen. Ein einziges Möbelstück bietet eine Vielzahl von Konfigurationsoptionen, so dass Flos perfekt für eine Vielzahl von Umgebungen geeignet ist. Zwei gleichermaßen komfortable Sitztypen - mit oder ohne Armlehnen - sind die Antwort auf die anspruchsvollen Bedürfnisse der heutigen Arbeitswelt.



FS KP 4W

Upholstered with Ally AL463
Metal finish RAL 9005 S

Table TB CONF3

Metal finish RAL 9005 S
Tableto: solid oak wood





FS K 4R

Upholstered with Pastel PA050
Metal finish RAL 9005 S

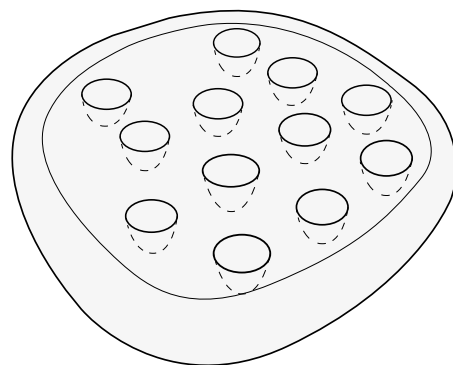

en:
Seat comfort

The decompression cones used in Flos seats further enhance seating comfort.

pl:
Komfort siedzenia

Stożki dekompresyjne wykorzystane w siedziskach Flos dodatkowo podnoszą komfort siedzenia.

de:
Sitzkomfort

Die in den Flos-Sitzen verwendeten Dekompressionskegel erhöhen den Sitzkomfort zusätzlich.



FS KP 4W

Upholstered with Charles CH 006
Metal finish RAL 9005 S





FS KP 4R

Upholstered with Synergy LDS49
Metal finish RAL 9005 S

TB CONF3 table

Metal finish RAL 9005 S
Table: solid oak wood





FS KP 215
Upholstered with Cura CR168
Metal finish RAL 9005 S



FS KP 215

Upholstered with Blazer CUZ1W
Metal finish RAL 9005 S



FS KP 215

Upholstered with Blazer CUZ1K
Metal finish RAL 9005 S

en:

Harmony and comfort

The flowing line of the form emphasises the aesthetic qualities of the Flos collection. It gives it a lightness, a touch of classic character, and a subtlety welcome in domesticated work spaces for relaxation and tranquillity.

pl:

Harmonia i komfort

Płynna linia formy podkreśla walory estetyczne kolekcji Flos. Nadaje jej lekkości, odrobiny klasycznego charakteru, a także subtelności mile widzianej w udomowionych przestrzeniach pracy służących odprężeniu i wyciszeniu.

de:

Harmonie und Komfort

Die fließende Linie der Form unterstreicht die ästhetischen Qualitäten der Kollektion Flos. Sie verleiht ihr eine Leichtigkeit, einen Hauch von klassischem Charakter und eine Subtilität, die in häuslichen Arbeitsräumen für Entspannung und Ruhe willkommen ist.

FS K 215

Upholstered with Pastel PA153

Metal finish RAL 9005 S

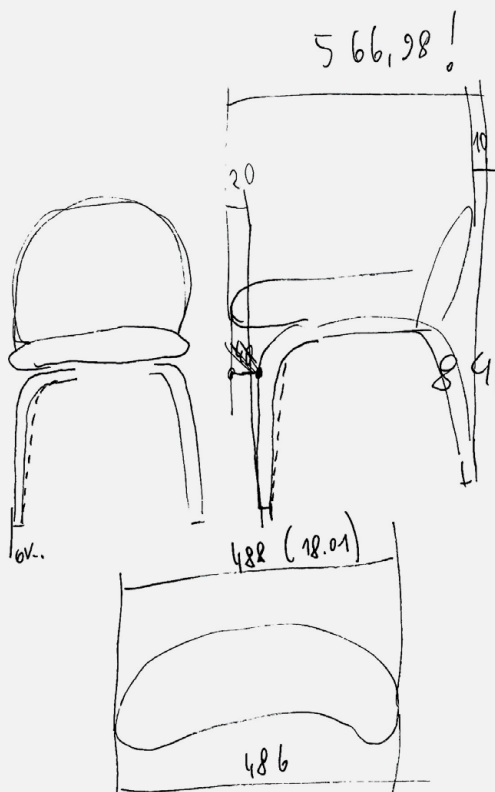

FS K 215

Upholstered with Pastel PA153

Metal finish RAL 9005 S

flos
chair collection



FS K 260

Upholstered with Remix RX852
Metal finish RAL 9005 S



FS KP 260

Upholstered with Blazer CUZ1W
Metal finish RAL 9005 S



en:

Chairs in motion

By complementing the soft bucket form with bases on castors, Flos chairs are perfect for both office interiors and home workplaces.

pl:

Krzesła w ruch

Dzięki uzupełnieniu miękkiej formy kubelka bazami na kółkach, krzesła Flos doskonale spełnią swoją rolę zarówno we wnętrzach biurowych, jak i domowych miejscach pracy.

de:

Stühle in Bewegung

Durch die Ergänzung der weichen Eimerform mit Fußgestellen auf Rollen eignen sich die Flos-Stühle sowohl für die Inneneinrichtung von Büros als auch für Heimarbeitsplätze.



FS K 260

Upholstered with Steelcut SC226
Metal finish RAL 9005 S

SNR DS 16L table

Metal finish RAL 9005 S
Laminated table top U999



FS F 420

Upholstered with Alpa AP005
Metal finish RAL 9005 S

FS TB RC table

Metal finish RAL 9005 S
Laminated table top U999

flos

lounge

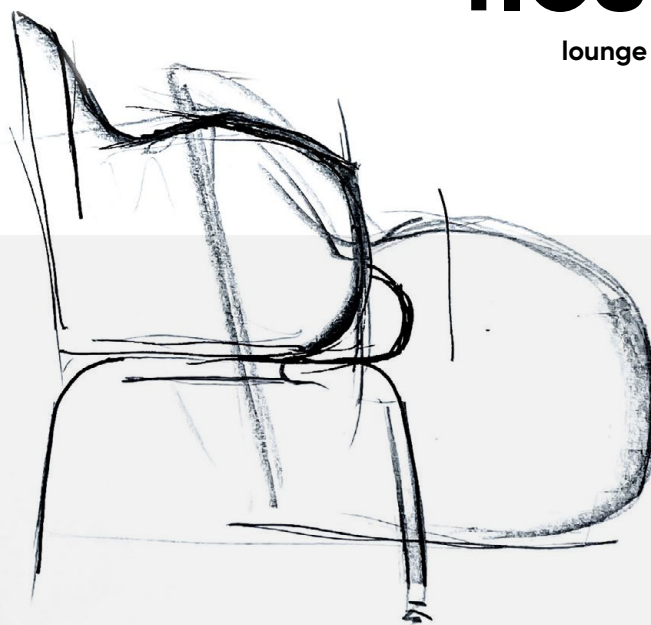

See lounge wood version:
page 28



FS F 420

Upholstered with AP006
Metal finish RAL 9005 S

en:

Lounge chairs

The lounging nature of the Flos armchair is a perfect balance of design, comfort and functionality. The armrests and backrest wrap around the soft seat, creating a contoured, ergonomic bucket for good body support and spinal relief. It is a piece of furniture that affects the senses.

pl:

Fotele lounge

Loungowy charakter fotela Flos to doskonały balans między designem, komfortem i funkcjonalnością. Podłokietniki i oparcie otulają miękkie siedzisko, tworząc wyprofilowany, ergonomiczny kubełek zapewniający dobre podparcie ciała i odciążenie kręgosłupa. To mebel, który oddziałuje na zmysły.

de:

Lounge-Sessel

Der Lounge-Charakter des Flos-Sessels ist eine perfekte Balance zwischen Design, Komfort und Funktionalität. Die Armlehnen und die Rückenlehne umschließen die weiche Sitzfläche und bilden eine ergonomisch geformte Schale, die den Körper gut stützt und die Wirbelsäule entlastet. Es ist ein Möbelstück, das die Sinne berührt.



FS F 420

Upholstered with Alpa AP006
Metal finish RAL 9005 S

Durable and soft – chairs on steel bases





Chair FSW F 720
Upholstered with AP005
Base: Oak O1

TB W 74 L table
Table top: laminate H1180
Base: Oak O1

flos wood lounge

low lounge bases

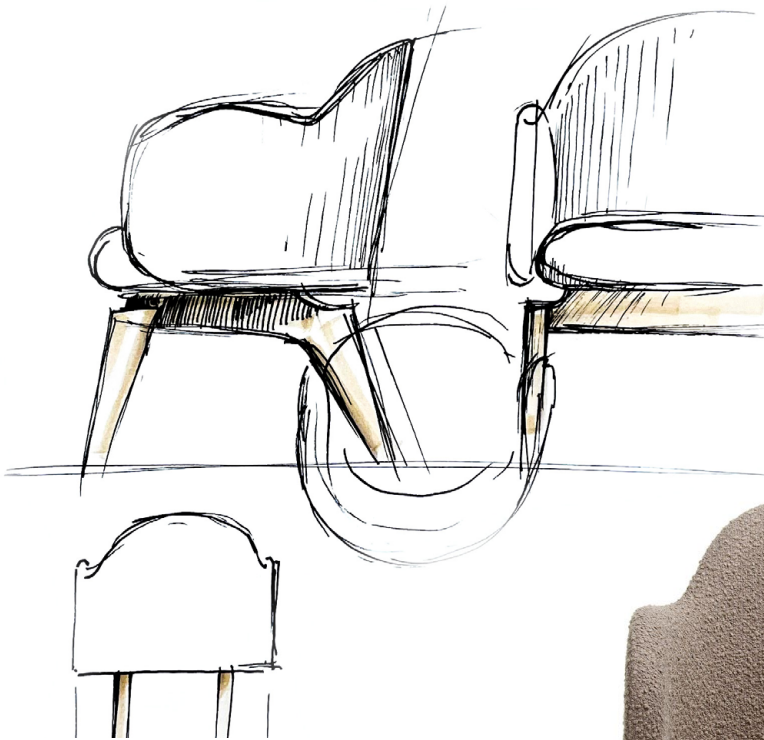

FS F 721

Upholstered with AP006

Base: Oak O1

en:

Biophilia encapsulated in ergonomics

The collection was inspired by a holistic combination of elements expressing peace and harmony. The organic shape of the solid referring to nature makes it possible to create an atmosphere conducive to building good interpersonal relationships.

pl:

Biofilia zamknięta w ergonomii

Inspiracją do stworzenia kolekcji było holistyczne połączenie elementów wyrażających spokój i harmonię. Organiczny kształt bryły nawiązujący do natury umożliwia tworzenie atmosfery sprzyjającej budowaniu dobrych relacji międzyludzkich.

de:

Biophilie in Ergonomie gekapselt

Die Kollektion wurde durch eine ganzheitliche Kombination von Elementen inspiriert, die Frieden und Harmonie ausdrücken. Die organische Form des Massivs, die sich auf die Natur bezieht, ermöglicht es, eine Atmosphäre zu schaffen, die dem Aufbau guter zwischenmenschlicher Beziehungen förderlich ist.



FSW F 720

Upholstered with Alpa AP006

Base: Oak O1



FSW F 740

Upholstered with Ally AL653

Base: metal finish RAL 9005 S

Legs: Oak O1



Chair FSW F 721
Upholstered with Alpa AP005
Base: Oak O1

TB W 74 L table
Table top: laminate H1180
Base: Oak O1



FSW K 721

Upholstered with Remix RX163

Base: Oak O1

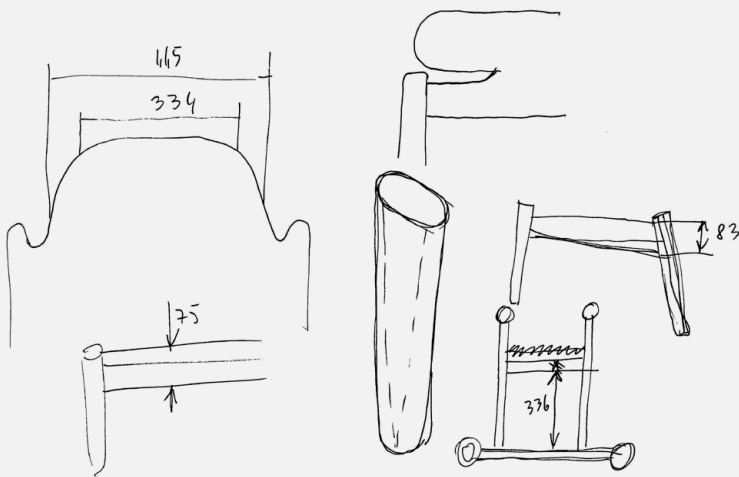

FSW KP 721

Upholstered with Ally AL124

Base: Oak O1

flos wood

chair and benches



FSW L722

Upholstered with Ally AL124

Base: Oak O1

en:

Praise of nature

The name of the collection refers to biophilia for a reason - 'flos' in Latin means flower. The organic shape of the solids evokes the streamlined shapes found in nature, which promotes the creation of domesticated work and leisure spaces.

pl:

Pochwała natury

Nazwa kolekcji nie bez przyczyny nawiązuje do biofilii - „flos” to po łacinie kwiat. Organiczny kształt bryły przywołuje na myśl opływowe kształty występujące w naturze, co sprzyja tworzeniu udomowionych przestrzeni pracy i wypoczynku.

de:

Lob der Natur

Der Name der Kollektion verweist nicht umsonst auf die Biophilie - „flos” bedeutet in Latin eine Blume. Die organische Form der Körper erinnert an die strömungsförmigen Formen in der Natur, was die Schaffung von domestizierten Arbeits- und Freizeiträumen fördert.



FSW K 740

Upholstered with Roccia RC153
Base: metal finish RAL 9005 S
Legs: Oak O1



FSW KP 740

Upholstered with Charles CH 006
Base: metal finish RAL 9005 S
Legs: Oak O1







FSW L740

Upholstered with Remix RX223

Base: metal finish RAL 9005 S

Legs: Oak O1





Focus on details





FS KP H

Upholstered with Remix RX 252
Metal finish RAL 9003 S

SN R TB 18H table

Metal finish RAL 9003 S
Table top U708 ST9

FS LH

Upholstered with Remix RX 252
Metal finish RAL 9003 S

flos stools & benches

dedicated for bar and coffee tables



FS K H

Upholstered with Roccia RC153
Metal finish RAL 9005 S



FS K HN

Upholstered with Roccia RC153
Metal finish RAL 9005 S

en:

Bar chairs and benches

Based on a single solid form, it is possible to create unique furniture that blends perfectly in a variety of arrangements. Hockers are currently used in office and restaurant interiors as well as in the home. In the case of integration-oriented spaces, the use of benches instead of chairs allows a less formal atmosphere to be created.

pl:

Krzesła barowe i ławki

Bazując na jednej formie bryły można stworzyć unikatowe meble znakomicie komponujące się w zróżnicowanych aranżacjach. Hokery wykorzystywane są obecnie zarówno we wnętrzach biurowych, restauracyjnych, jak i domowych zaciszach. W przypadku przestrzeni nastawionych na integrację, wykorzystanie ławek zamiast krzeseł pozwala zbudować mniej formalną atmosferę.

de:

Barstühle und Bänke

Auf der Grundlage einer einzigen soliden Form können einzigartige Möbel geschaffen werden, die sich perfekt in eine Vielzahl von Arrangements einfügen. Hockerbänke werden derzeit in Büros und Restaurants sowie im privaten Bereich eingesetzt. In integrationsorientierten Räumen kann durch die Verwendung von Bänken anstelle von Stühlen eine weniger formelle Atmosphäre geschaffen werden.

FS KP HN

Upholstered with Leather S 478
Metal finish RAL 9005 S



The bar chairs and high and low benches from the Flos collection match perfectly with the minimalist Spin tables./
Krzesła barowe oraz ławki wysokie i niskie z kolekcji Flos idealnie komponują się z minimalistycznymi stołami Spin./
Die Barstühle sowie die hohen und niedrigen Bänke aus der Flos-Kollektion passen perfekt zu den minimalistischen Spin-Tischen.



SN R TB 18H
Metal finish RAL 9005 S



FS KP HN
Upholstered with Leather S 478
Metal finish RAL 9005 S



FS KP H

Upholstered with Remix RX 452

Metal finish RAL 9003 S

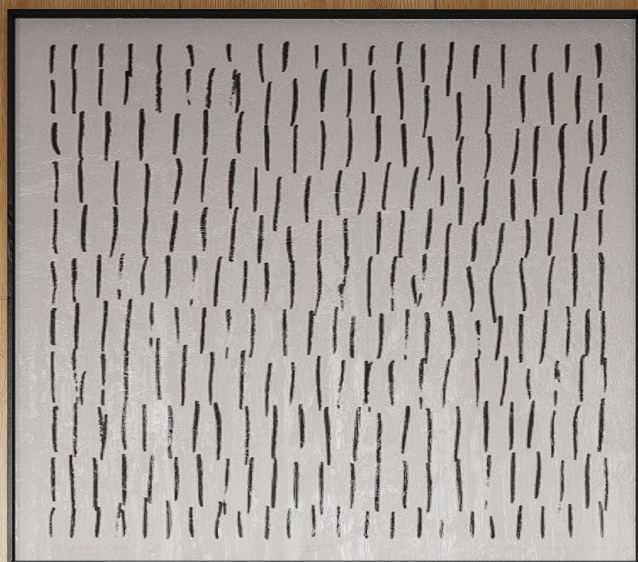

Chair FS K 215

Upholstered with Roccia RC655
Metal finish RAL 9005 S

FS L215

Upholstered with Roccia RC655
Metal finish RAL 9005 S

FS TB RC table

Metal finish RAL 9005 S
Laminated table top U999



FS L215
Upholstered with Remix RX173
Metal finish RAL 9005 S



FS LHN
Upholstered with Remix RX173
Metal finish RAL 9005 S



FS LH
Upholstered with Remix RX 173
Metal finish RAL 9005 S

Complete your collection





en:
Complete your Flos collection with
wall, ceiling and freestanding acous-
tic panels.

pl:
Uzupełnij swoją kolekcję Flos o panele
akustyczne ścienne, sufitowe i wolno-
 stojące.

de:
Vervollständigen Sie Ihre Flos-Kollek-
tion mit Wand-, Decken- und freiste-
henden Akustikpaneelen.

Flos chairs



FS K 5R



FS KP 5R



FS K 4W



FS KP 4W



FS K 4R



FS KP 4R

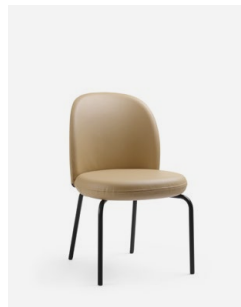

FS K 215

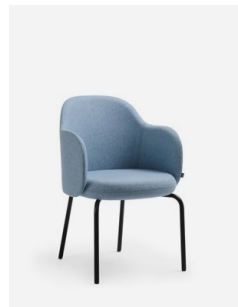

FS KP 215



FS K 260



FS KP 260

en:

Base

Powder coated (colors according to the Bejot sampler).

pl:

Baza

Malowana proszkowo (kolorystyka wg wzornika Bejot).

de:

Gestell

Pulverbeschichtet (Farbgebung nach Bejot-Musterkatalog).

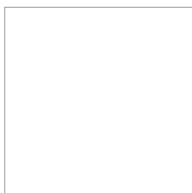

RAL 9003 - S

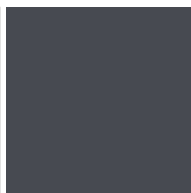

RAL 7024 - S

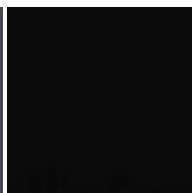

RAL 9005 - S



More colours
Więcej kolorów
Mehr Farben

Technical data

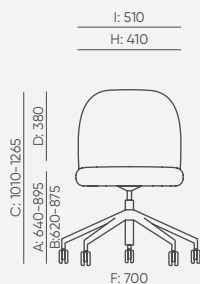

FS K 5R

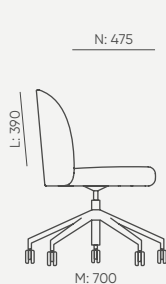

FS KP 5R

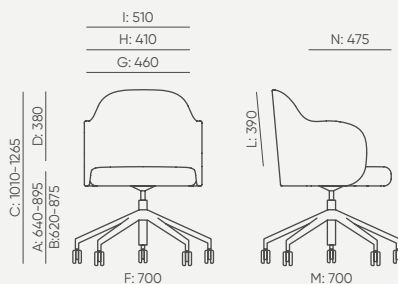

FS K 4W

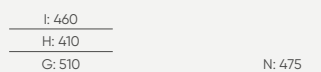
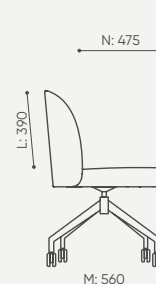

FS KP 4W



FS K 4R



FS KP 4R

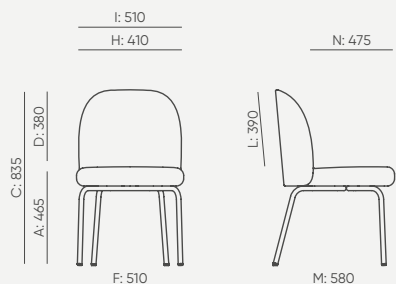

FS K 215

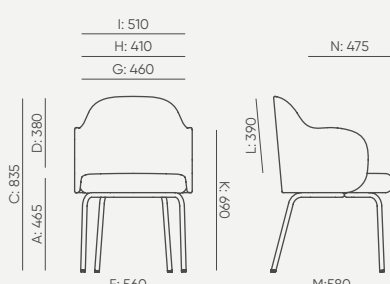

FS KP 215

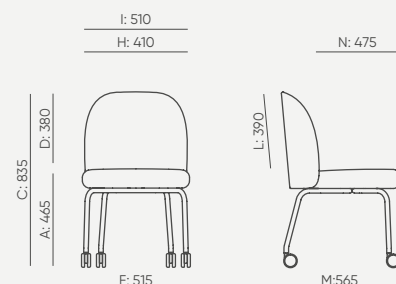

FS K 260

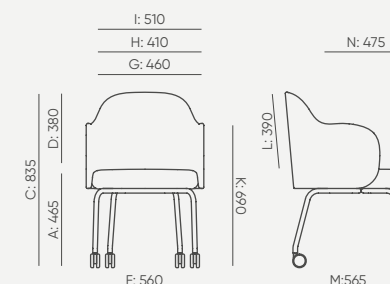

FS KP 260

en:

Dimensions and weights are approximate and may vary by 5%. The data is given for the basic configuration of products. The requirements of the standard are always met.

pl:

Wymiary i wagi mają charakter orientacyjny i mogą się różnić o 5%. Dane podane są do podstawowych konfiguracji produktów. Zawsze spełnione są wymogi normy.

de:

Abmessungen und Gewichte sind ungefähr und können um 5% variieren. Die Daten sind für die Grundkonfiguration von Produkten angegeben. Die Anforderungen der Norm werden immer erfüllt.

Flos wood & lounge



FSW F 720



FSW K 721



FS W KP 721



FSW L722



FSW F 740



FSW K 740



FSW KP 740



FSW L740



FS F 420



FS TB RC

en:

Base

Powder coated (colors according to the Bejot sampler).

pl:

Baza

Malowana proszkowo (kolorystyka wg wzornika Bejot).

de:

Gestell

Pulverbeschichtet (Farbgebung nach Bejot-Musterkatalog).

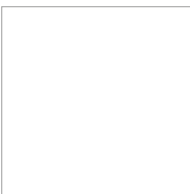

RAL 9003 - S

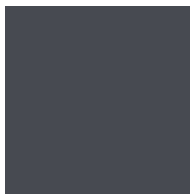

RAL 7024 - S

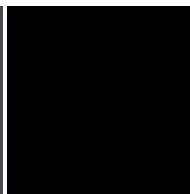

RAL 9005 - S



More colours
Więcej kolorów
Mehr Farben

en:

Wood base

Solid oak wood - natural color (O1)

pl:

Drewniana baza

Drewno lite dqb - kolor naturalny (O1)

de:

Sockel aus Holz

Massives Eichenholz - naturfarben (O1)

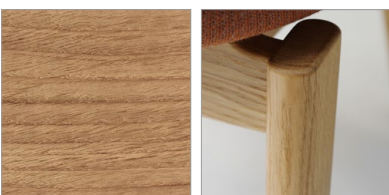

O1

Technical data

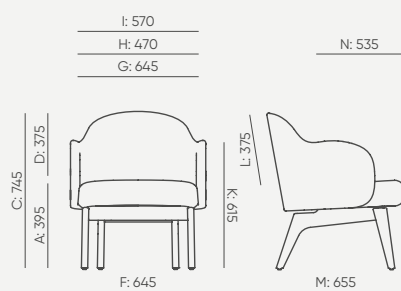

FS W 720

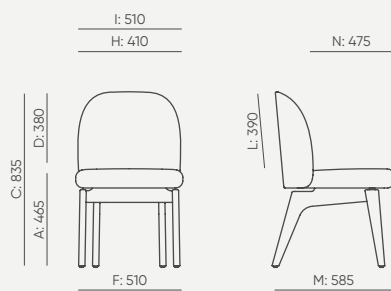

FSW K 721

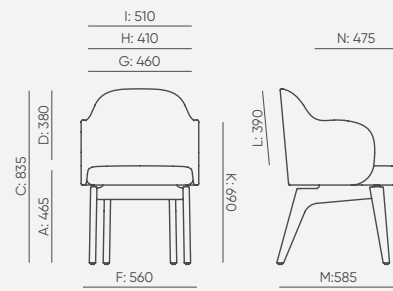

FSW KP 721

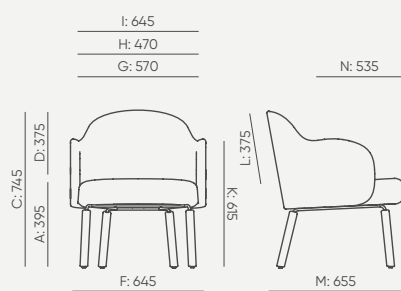

FSW F 740

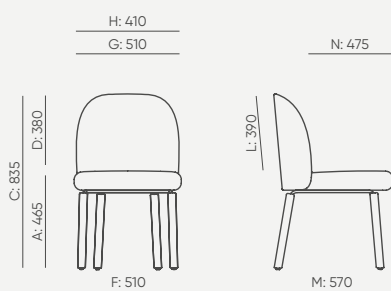

FSW K 740

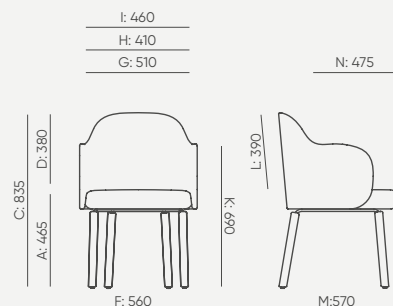

FSW KP 740

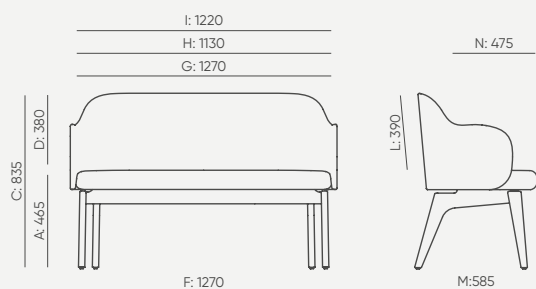

FSW L 722

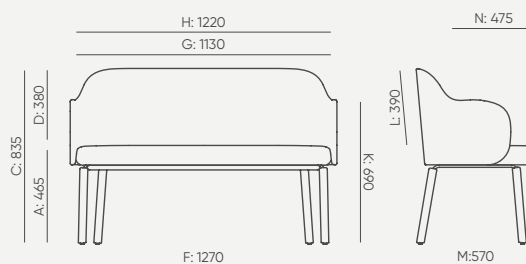

FSW L 740

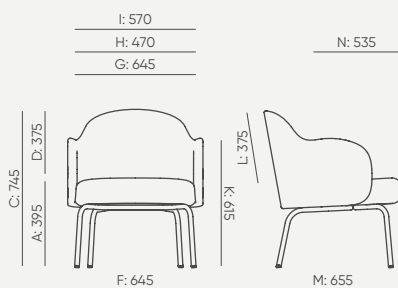

FS F 420

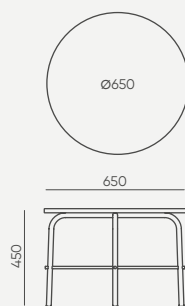

FS TB RC

en:

Dimensions and weights are approximate and may vary by 5%. The data is given for the basic configuration of products. The requirements of the standard are always met.

pl:

Wymiary i wagi mają charakter orientacyjny i mogą się różnić o 5%. Dane podane są do podstawowych konfiguracji produktów. Zawsze spełnione są wymogi normy.

de:

Abmessungen und Gewichte sind ungefähr und können um 5% variieren. Die Daten sind für die Grundkonfiguration von Produkten angegeben. Die Anforderungen der Norm werden immer erfüllt.

Flos stool & benches

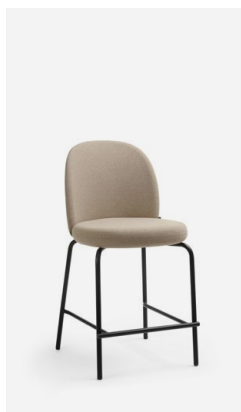

FS K HN

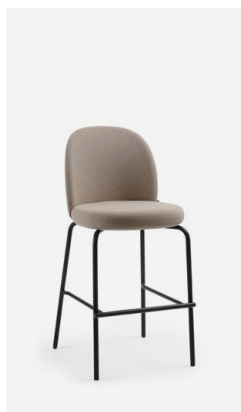

FS K H

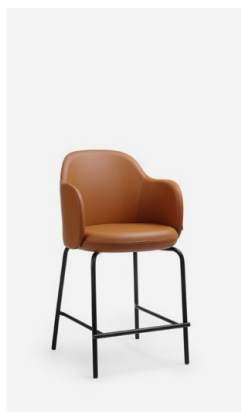

FS KP HN

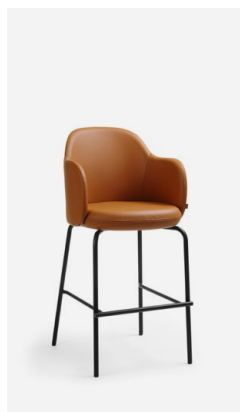

FS KP H



FS L215



FS LHN



FS LH

en:

Base

Powder coated (colors according to the Bejot sampler).

pl:

Baza

Malowana proszkowo (kolorystyka wg wzornika Bejot).

de:

Gestell

Pulverbeschichtet (Farbgebung nach Bejot-Musterkatalog).



RAL 9003 - S

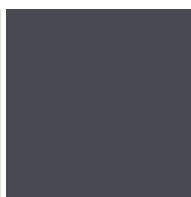

RAL 7024 - S

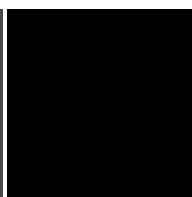

RAL 9005 - S



More colours
Więcej kolorów
Mehr Farben

Technical data

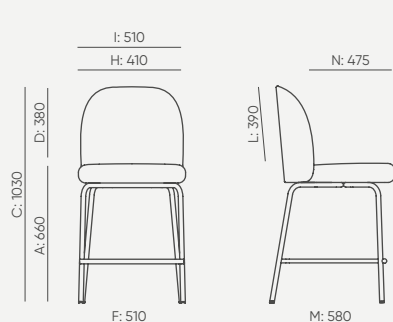

FS K HN

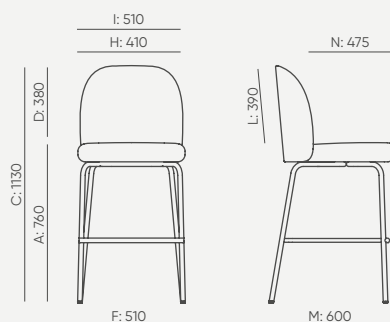

FS K H

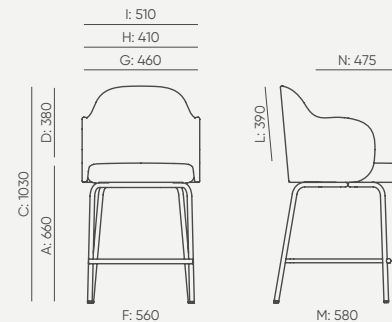

FS KP HN

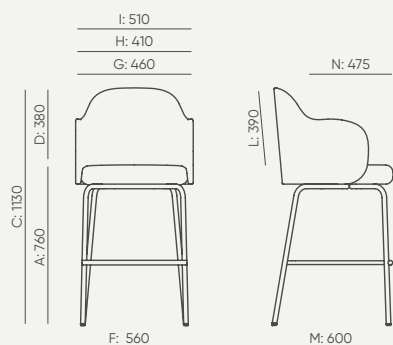

FS KP H

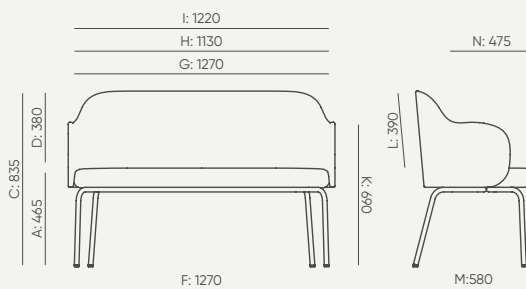

FS L 215

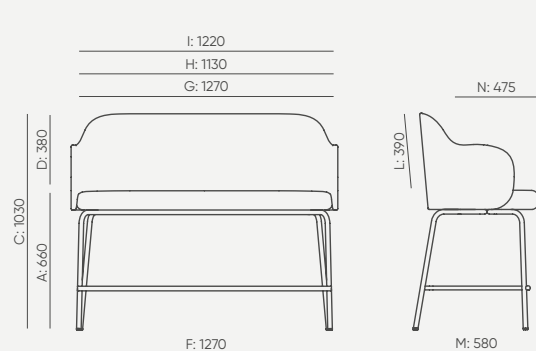

FS L HN

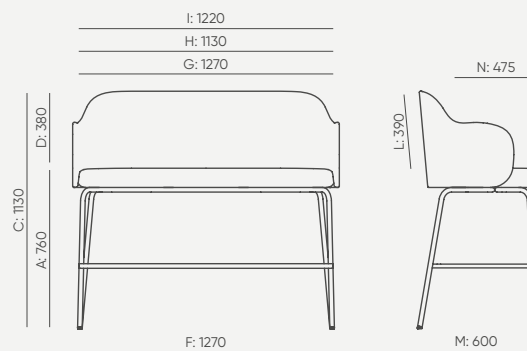

FS L H

en:

Dimensions and weights are approximate and may vary by 5%. The data is given for the basic configuration of products. The requirements of the standard are always met.

pl:

Wymiary i wagi mają charakter orientacyjny i mogą się różnić o 5%. Dane podane są do podstawowych konfiguracji produktów. Zawsze spełnione są wymagania normy.

de:

Abmessungen und Gewichte sind ungefähr und können um 5% variieren. Die Daten sind für die Grundkonfiguration von Produkten angegeben. Die Anforderungen der Norm werden immer erfüllt.

be:sustainable

product life-cycle management



en:

Quality, design and ergonomics are synonymous with Bejot's definition of sustainable development. We are socially responsible, honest and an environmentally friendly. **Flos collection** has been designed with sustainable solutions in mind, it is manufactured from certified materials, with optimized manufacturing processes and consistent control of production waste. Our goal is comfort in the office, which is reflected within our organization as well as in every piece of furniture we produce. We are helping our customers extend the life of our products by providing a 5-year warranty and after-warranty service, and we are introducing policy aimed at minimising waste at the end of the product life cycle.

pl:

Jakość, design i ergonomia to synonimy zrównoważonego rozwoju Bejot. Jesteśmy społecznie odpowiedzialni, działamy uczciwie i w sposób przyjazny dla środowiska. **Flos** został zaprojektowany z uwzględnieniem proekologicznych rozwiązań. Jest produkowany z certyfikowanych materiałów, przy optymalizacji procesów produkcyjnych i konsekwentnym kontrolowaniu odpadów produkcyjnych. Nasz cel to osiągnięcie komfortu w biurze, który przejawia się zarówno wewnątrz naszej organizacji, jak i w każdym wyprodukowanym przez nas meblu. Pomagamy klientom wydłużyć czas eksploatacji naszych produktów zapewniając 5 lat gwarancji i serwis pogwarancyjny, a także wprowadzamy zasadę minimalizacji odpadów po zakończonym cyklu życia produktu.

de:

Qualität, Design und Ergonomie sind Synonyme der nachhaltigen Entwicklung, die von Bejot realisiert wird. Wir setzen auf soziale Verantwortung, handeln fair und umweltbewusst. Die **Flos Sitze** wurden unter Berücksichtigung pro-ökologischer Lösungen entwickelt. Sie werden aus zertifizierten Materialien, aus optimierten Produktionsprozessen und unter konsequenter Kontrolle der Produktionsabfälle hergestellt. Unser Ziel ist Komfort im Büro zu garantieren, der innerhalb unserer Organisation sowie in Form jedes von uns hergestellten Möbelstücks zu sehen sein wird. Wir helfen den Kunden die Lebensdauer unserer Produkte zu verlängern, dies dank einer 5-Jahres-Garantie sowie einem Nachgarantieservice. Wir realisieren auch das Prinzip der Abfallminimierung am Ende des Produktlebenszyklus.

Flos collection – ecology and recycling

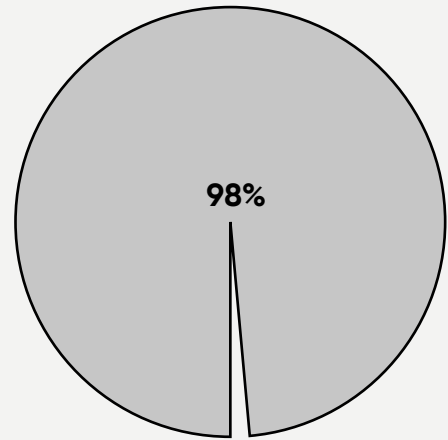
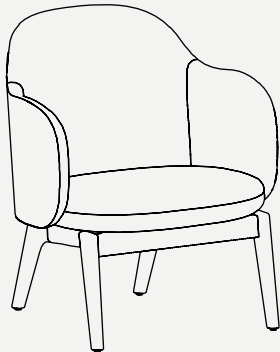

en:
We care about the environment

We use recyclable materials, e.g. in the sample Flos FSW F 720 chair presented above, we can reuse as much as 98% of the initial materials.

pl:
Dbamy o środowisko

Używamy materiałów podlegających recyklingowi, np. w powyższym przykładowym modelu krzesła Flos FSW F 720 możemy wykorzystać ponownie aż 98% mebla.

de:
Wir Schützen unsere Umwelt

Wir verwenden wiederverwertbare Materialien, wie z.B. bei den Flos FSW F 720 Sitzen oben, können wir bis zu 98% des Möbelstücks wiederverwenden.



wood / drewno / Holz



steel / stal / Stahl

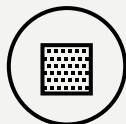

foam / pianka / Schaum

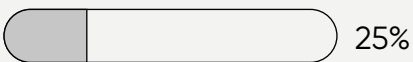

upholstery / tapicerka / Polster



en:
Material composition

Percentage share of the weight of a given raw material on the example of FSW F 720 chair.

pl:
Skład materiałowy

Procentowy udział masy danego surowca w przykładowym fotelu FSW F 720.

de:
Materialzusammensetzung

Prozentualer Gewichtsanteil eines bestimmten Rohstoffs im beispielhaften Stuhl FSW F 720.

Bejot sp. z o.o.

ul. Wybickiego 2A, Manieczki, 63-112 Brodnica n. Poznań, POLAND

tel.: +48 (61) 281 22 25, e-mail: marketing@bejot.eu

www.bejot.eu