

.mdd
Pracowniczy
v8.2021

Zestawienie kolorystyczne - Ścianki działowe

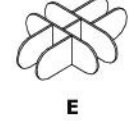
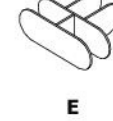
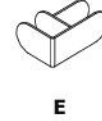
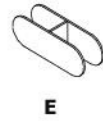
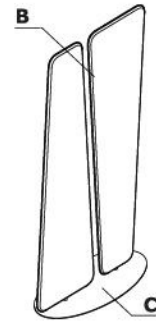
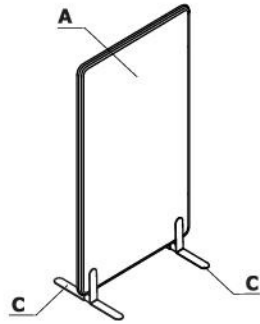

Materiał	Kolor	Ścianki działowe															
		A - Sonic	B - Viva	C - Stelaż	E - Akcesoria												
Tkanina	Nemo	✓	✓														
	Runner	II grupa	II grupa														
	Medley	II grupa	II grupa														
	**Atlantic	II grupa	II grupa														
	Vita	II grupa	II grupa														
	Mica	II grupa	II grupa														
	Go Check	II grupa	II grupa														
	Charles	II grupa	II grupa														
	Xtreme	III grupa	III grupa														
	Synergy	III grupa	III grupa														
	***Silvertex	III grupa	III grupa														
	*Tkanina powierzona	II grupa	II grupa														
	Atlas	IV grupa	IV grupa														
	Field2	IV grupa	IV grupa														
Metal	M009 - aluminium półmat RAL 9006			✓	✓												
	M015 - biały półmat RAL 9010			✓	✓												
	M154 - antracyt półmat RAL 7043			✓	✓												
	M115 - czarny półmat RAL 9005			✓	✓												

* Zastosowanie tkaniny powierzonej wymaga przeprowadzenia prób tapicerskich, w celu sprawdzenia możliwości wykonawczych

*** Istnieje możliwość zamówienia produktu w pełnej kolorystyce Silvertex wg wzornika Spradling w terminie nie krótszym niż 15 dni roboczych

** Istnieje możliwość zamówienia produktu w pełnej kolorystyce Atlantic wg wzornika Gabriel w terminie nie krótszym niż 7 dni roboczych

Sonic - panele wolnostojące

- 1 **Panel** - klasa akustyczności "A", tapicerowany; możliwość wpinania szpilek
- 2 **Zamek błyskawiczny** - ozdobny, bez możliwości odpinania, kolor: grafit
- 3 **Rama** - konstrukcja z litego drewna klejonego
- 4 **Wypełnienie** - włóknina akustyczna o wysokim stopniu pochłaniania i rozpraszania dźwięków
- 5 **Stopa wolnostojąca** - metal malowany proszkowo
- 6 **Stopka dystansowa** - metal malowany proszkowo; do zastosowania wyłącznie w panelach ustawianych pomiędzy biurkami, lub z innym stabilnym podparciem z obu stron
- 7 **Tablica magnetyczna** - suchościerna

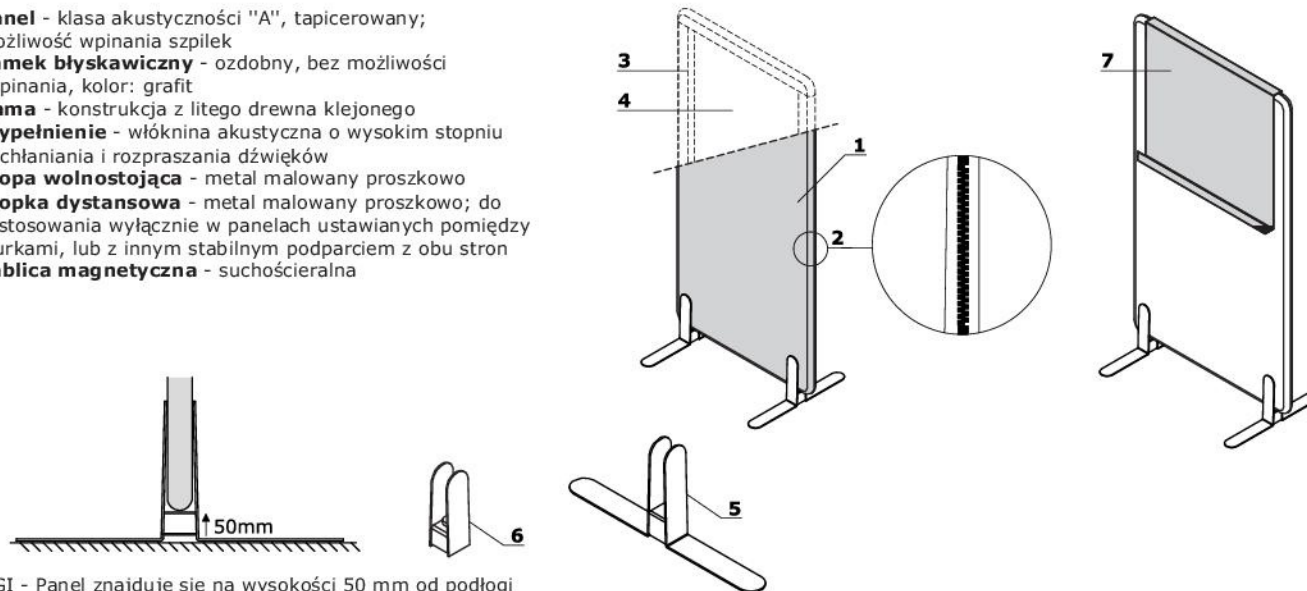

UWAGI - Panel znajduje się na wysokości 50 mm od podłogi

Łączniki do paneli wolnostojących Sonic



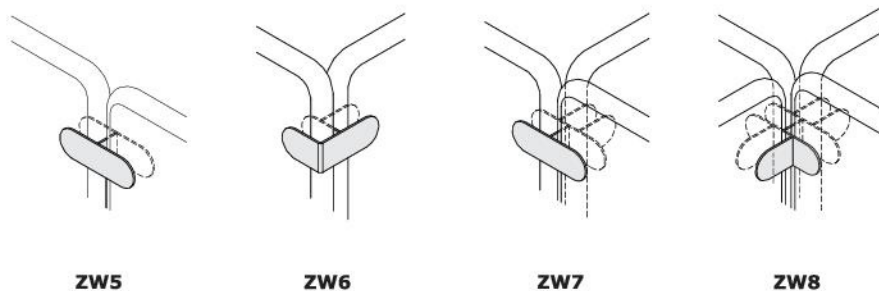

- 1 **Łącznik** - metal malowany proszkowo



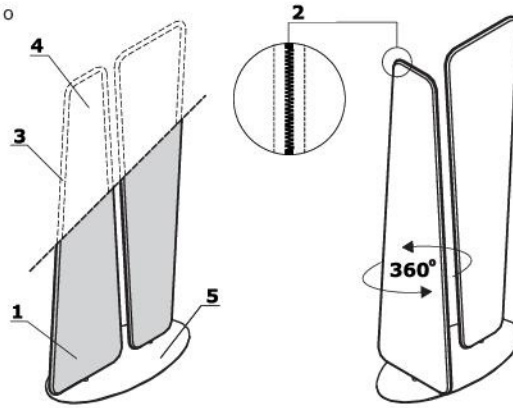
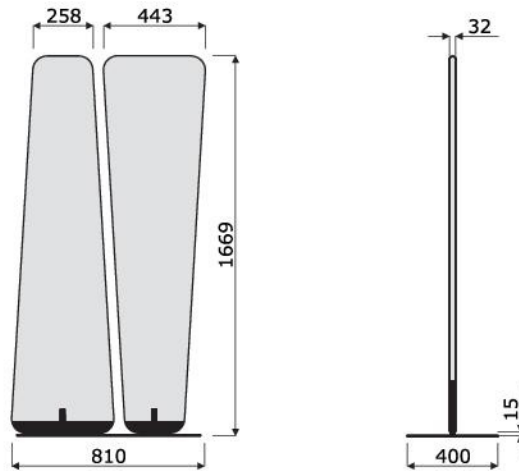

Viva - panel wolnostojący

- 1 Panel** - tapicerowany, konstrukcja wykonana w technologii paneli Sonic, posiadających certyfikat akustyczności klasy A, możliwość wpinania szpilek
- 2 Zamek błyskawiczny** - ozdobny, bez możliwości odpinania, kolor: grafit
- 3 Rama** - rura stalowa
- 4 Wypełnienie** - włóknina akustyczna o wysokim stopniu pochłaniania i rozpraszania dźwięków
- 5 Stopa metalowa** - metal malowany proszkowo
- 6 Obrót 360°** - każdy z paneli obraca się niezależnie

**Viva - wymiary (mm)**

Sonic - panele wolnostojące							
Symbol	Wymiary	Symbol			Waga Obj. Opak.	Uwagi	
		Szer.	Gł.	Wys.			
	ZW592	590	40	1250	11.5 kg 0.065 m ³ 5 szt.		
	ZW594	590	40	1450	16.9 kg 0.071 m ³ 5 szt.		
	ZW596	590	40	1650	13 kg 0.077 m ³ 5 szt.		
	ZW598	590	40	1850	18.9 kg 0.083 m ³ 5 szt.		
	ZW692	690	40	1250	16.4 kg 0.071 m ³ 5 szt.		
	ZW694	690	40	1450	17.4 kg 0.078 m ³ 5 szt.		
	ZW696	690	40	1650	13.6 kg 0.085 m ³ 5 szt.		
	ZW698	690	40	1850	14.5 kg 0.092 m ³ 5 szt.		
	ZW792	790	40	1250	12.4 kg 0.077 m ³ 5 szt.		
	ZW794	790	40	1450	13.2 kg 0.085 m ³ 5 szt.		
	ZW796	790	40	1650	14.2 kg 0.093 m ³ 5 szt.		
	ZW798	790	40	1850	15.1 kg 0.101 m ³ 5 szt.		
	ZW892	890	40	1250	12.8 kg 0.083 m ³ 5 szt.		
	ZW894	890	40	1450	13.9 kg 0.092 m ³ 5 szt.		
	ZW896	890	40	1650	19.4 kg 0.101 m ³ 5 szt.		
	ZW898	890	40	1850	20.4 kg 0.11 m ³ 5 szt.		

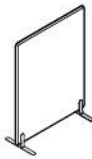
I grupa cenowa	II grupa cenowa	III grupa cenowa						

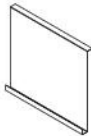
Sonic - panele wolnostojące							
	Symbol		Wymiary			Waga Obj. Opak.	Uwagi
			Szer.	Gł.	Wys.		
	ZW992		990	40	1250	13.7 kg 0.089 m3 5 szt.	
	ZW994		990	40	1450	14.3 kg 0.099 m3 5 szt.	
	ZW996		990	40	1650	16.1 kg 0.109 m3 5 szt.	
	ZW998		990	40	1850	18.1 kg 0.12 m3 5 szt.	
Łączniki do paneli wolnostojących Sonic							
	ZW5		150	37 36.5	50	0.37 kg 0 m3 1 szt.	
	ZW6		150	116	50	0.37 kg 0.001 m3 1 szt.	
	ZW7		150	116	50	0.53 kg 0.001 m3 1 szt.	
	ZW8		150	190 189.5	50	0.69 kg 0.001 m3 1 szt.	
Sonic - panele wolnostojące - akcesoria							
	TB01		700	92	635	4.5 kg 0.046 m3 1 szt.	tablica magnetyczna - suchościerna

I grupa cenowa	II grupa cenowa	III grupa cenowa								









Viva - panel wolnostojący							
	Symbol		Wymiary			Waga Obj. Opak.	Uwagi
	VV02		Szer.	Gł.	Wys.		
	VV02		850	400	1670	20.4 kg 0.084 m3 3 szt.	

I grupa cenowa	II grupa cenowa	III grupa cenowa					



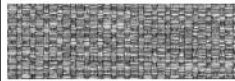







Metal

 M009 - aluminium półmat RAL 9006	 M015 - biały półmat RAL 9010	 M115 - czarny półmat RAL 9005	 M154 - antracyt półmat RAL 7043
--	--	---	--

Tkanina Nemo - I grupa cenowa

 NE-1 - beżowy	 NE-2 - żółty	 NE-3 - pomarańczowy	 NE-5 - czerwony	 NE-9 - zielony	 NE-10 - szary	 NE-14 - grafitowy	 NE-15 - granatowy
 NE-16 - czarny	 NE-17 - niebieski						









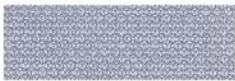

Tkanina Runner - II grupa cenowa

 R-63034 - pomarańczowy	 R-64089 - czerwony	 R-66063 - niebieski	 R-60011 - szary	 R-68056 - zielony	 R-66064 - granatowy	 R-60999 - czarny	 R-60025 - grafitowy
 R-61128 - beżowy	 R-61130 - brązowy						

Tkanina Medley - II grupa cenowa

 M-66008 - szary	 M-60003 - jasny szary	 M-61189 - beżowy	 M-68005 - oliwka ciemna	 M-62002 - żółty	 M-62054 - musztardowy	 M-63017 - rdzawy	 M-64019 - czerwony
 M-63064 - różowy	 M-65011 - szaro fioletowy	 M-66010 - niebieski	 M-67006 - niebieski jasny	 M-60999 - czarny			

Tkanina Atlantic - II grupa cenowa (Pozostałe kolory Atlantic wg wzornika Gabriel dostępne w terminie nie krótszym niż 7 dni roboczych)

 A-67043 - ciemny turkus	 A-67030 - morski	 A-60141 - jasnoszary	 A-60011 - szary	 A-66064 - granatowy	 A-65037 - fioletowy	 A-62048 - oliwkowy	 A-64089 - czerwony
 A-61078 - beżowy	 A-60025 - grafitowy						



















Tkanina Vita - II grupa cenowa

 V-01 - jasny szary	 V-02 - beżowy	 V-03 - żółty	 V-04 - szary	 V-07 - ciemny szary	 V-09 - oliwkowy	 V-10 - szaro brązowy	 V-11 - rdzawy
 V-12 - czarny	 V-13 - czekoladowy	 V-18 - morski	 V-19 - niebieski	 V-29 - ciemny zielony			

Tkanina Go check - II grupa cenowa

 G-66136 - niebieski	 G-66137 - niebieski ciemny	 G-66134 - fiolet ciemny	 G-66138 - granatowy	 G-66140 - atramentowy	 G-68149 - ciemny zielony	 G-68152 - zielony	 G-60079 - szary
 G-64183 - marsala	 G-63079 - pomarańczowy	 G-64171 - czerwony	 G-64172 - bordowy	 G-61144 - brązowy	 G-61145 - brązowy ciemny		

Tkanina Mica - II grupa cenowa

 MC-01 - różowy	 MC-02 - czerwony	 MC-03 - ciemny czerwony	 MC-04 - granatowy	 MC-05 - niebieski	 MC-06 - morski	 MC-07 - zielony butelkowy	 MC-08 - zielony
 MC-09 - oliwkowy	 MC-10 - oliwka jasna	 MC-11 - musztardowy	 MC-12 - żółty	 MC-13 - beżowy	 MC-14 - jasny szary	 MC-15 - szary	 MC-16 - grafitowy
 MC-17 - niebieski jasny	 MC-18 - miętowy	 MC-19 - bordowy					

Tkanina Charles - II grupa cenowa

 C-01 - czarny	 C-05 - szary	 C-06 - beżowy	 C-14 - brązowy	 C-18 - rdzawy	 C-21 - czerwony	 C-30 - różowy	 C-31 - marsala
 C-32 - niebieski ciemny	 C-35 - niebieski	 C-41 - żółty	 C-44 - oliwkowy	 C-45 - zielony			

Tkanina Synergy - III grupa cenowa

 LDS88 - oberżyna	 LDS86 - czerwony	 LDS85 - koralowy	 LDS84 - pomarańczowy	 LDS69 - granatowy	 LDS61 - śliwkowy	 LDS60 - zielony butelkowy	 LDS50 - ciemny zielony
 LDS53 - zielony	 LDS57 - turkusowy	 LDS29 - ciemny szary	 LDS27 - czarny	 LDS20 - jasny szary	 LDS08 - szary melanż	 LDS19 - beżowy	 LDS44 - żółty
 LDS79 - brązowy							

Tkanina Xtreme - III grupa cenowa











 XR108 - beżowy	 XR094 - szary	 XR081 - ciemny szary	 XR420 - oliwkowy	 XR009 - czarny	 XR026 - granatowy	 YS071 - jasny brąz	 YS030 - bordowy
 YS076 - pomarańczowy	 YS072 - żółty	 YS045 - zielony	 YS100 - niebieski				

Tkanina Silvertex - III grupa cenowa - Istnieje możliwość zamówienia produktu w pełnej kolorystyce Silvertex wg wzornika Spradling w terminie nie krótszym niż 15 dni roboczych.

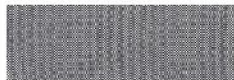
Tkanina Atlas - IV grupa cenowa

 AS-531 - pomarańczowy	 AS-501 - różowy	 AS-651 - czerwony	 AS-681 - bordowy	 AS-391 - brązowy	 AS-781 - granatowy	 AS-161 - ciemny szary	 AS-111 - jasny szary
 AS-971 - jasny zielony	 AS-981 - ciemny zielony						

Tkanina Field2 - IV grupa cenowa

 FD-463 - żółty	 FD-963 - zielony	 FD-123 - beżowy	 FD-132 - szary	 FD-142 - grafit	 FD-662 - czerwony	 FD-782 - granatowy	 FD-693 - bordowy
 FD-192 - czarny	 FD-673 - niebiesko-czerwony						