

.mdd
Gabinetowy
v8.2021

Zestawienie kolorystyczne - Crystal

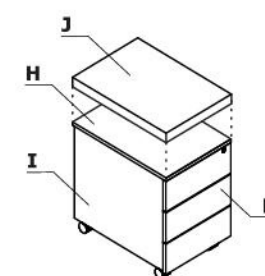
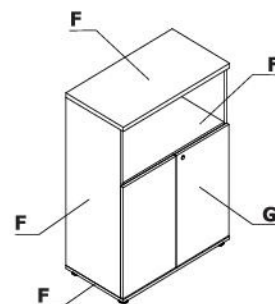
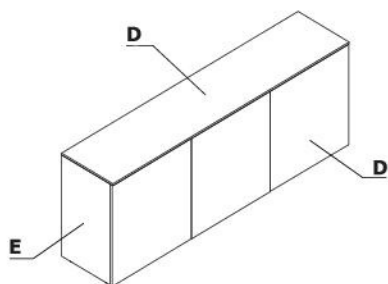
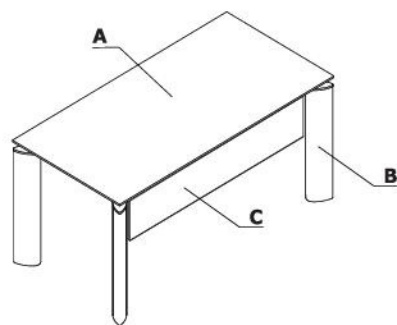

Materiał	Kolor	Blurka i stół konferencyjny			Komoda		Szafy		Kontener bezuchwytywy - mobilny		Elementy uzupełniające				
		A - Blat	B - Stelaz	C - Blenda płytowa	D - Wieniec górny, front	E - Korpus	F - Wieniec górny i dolny, korpus	G - Front	H - Wieniec górny, front	I - Korpus	A800GT	J - SKP13			
Płyta	08 - czarny	✓		✓	✓	08 - czarny	✓			✓	Szko czarne				
	31 - dąb kanadyjski	✓			✓	31 - dąb kanadyjski									
	34 - kasztan	✓			✓	34 - kasztan									
	67 - biały pastel	✓		✓	✓	67 - biały pastel	✓			✓	Szko białe				
	167 - dąb szary	✓			✓	167 - dąb szary									
	168 - dąb naturalny	✓			✓	168 - dąb naturalny									
	171 - orzech ciemny	✓			✓	171 - orzech ciemny									
Szko	116 - szkło czarne - RAL 9005	✓			✓	08 - czarny									
	117 - szkło białe - RAL 9003	✓			✓	67 - biały pastel									
Metal	M115 - czarny półmat RAL 9005		✓												
	M015 - biały półmat RAL 9010		✓												

Materiał	Kolor	Biuorka i stół konferencyjny			Komoda		Szafy		Kontener bezuchwytowy - mobilny		Elementy uzupełniające			
		A - Blat	B - Stelaż	C - Blendaplytowa	D - Wieniec górny, front	E - Korpus	F - Wieniec górny i dolny, korpus	G - Front	H - Wieniec górny, front	I - Korpus	A800GT	J - SKP13		
Tkanina	Nemo											✓		
	Runner											II grupa	✓	
	Medley											II grupa	✓	
	**Atlantic											II grupa	✓	
	Vita											II grupa	✓	
	Mica											II grupa	✓	
	Go Check											II grupa	✓	
	Charles											II grupa	✓	
	Xtreme											III grupa	✓	
	Synergy											III grupa	✓	
	***Silvertex											III grupa	✓	
	*Tkanina powierzona											II grupa	✓	
	Atlas											IV grupa	✓	
	Field2											IV grupa	✓	
HPL	73 - biały połysk							✓	✓					
	101 - czarny połysk							✓	✓					
	148 - szary połysk							✓						
	155 - antracyt połysk							✓						
	174 - beżowy mat							✓						
	175 - trufłowy mat							✓						
	176 - czerwony mat							✓						
	177 - szary mat RAL 7042							✓						
	178 - avocado mat							✓						
	179 - zielony butelkowy mat							✓						
	180 - błękitny pruski mat							✓						
184 - błękitny mat							✓							

* Zastosowanie tkaniny powierzonej wymaga przeprowadzenia prób tapicerskich, w celu sprawdzenia możliwości wykonawczych

*** Istnieje możliwość zamówienia produktu w pełnej kolorystyce Silvertex wg wzornika Spradling w terminie nie krótszym niż 15 dni roboczych

** Istnieje możliwość zamówienia produktu w pełnej kolorystyce Atlantic wg wzornika Gabriel w terminie nie krótszym niż 7 dni roboczych

Biurka**1 Blat** - do wyboru:

- płyta melaminowana 12 mm, obrzeża ABS
- szkło hartowane, satynowane, matowe 10 mm, kolor: biały (ultra clear), czarny, malowane od spodu

2 Element ozdobny - chromowany**3 Nogi** - profil aluminiowy, malowany proszkowo z detalami chromowanymi**4 Profil** - metal malowany proszkowo, kolor: 08 czarny**5 Regulator poziomu** - regulacja w zakresie 5 mm**6 OPCJA Z DOPLATĄ** - wyłącznie do biurkek z blatem płytowym:

- Mediaport S91E - 2x 230V, 2x RJ45

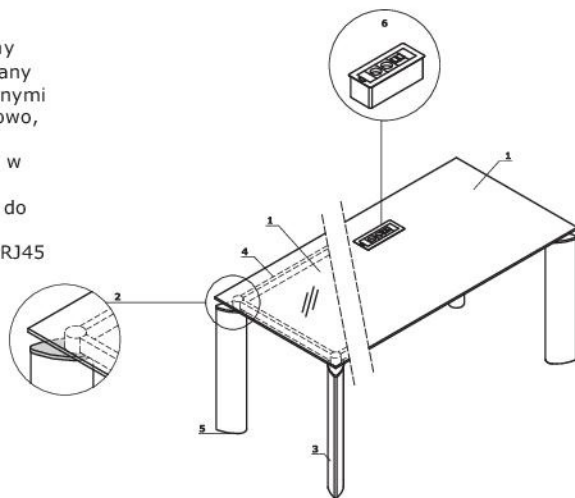
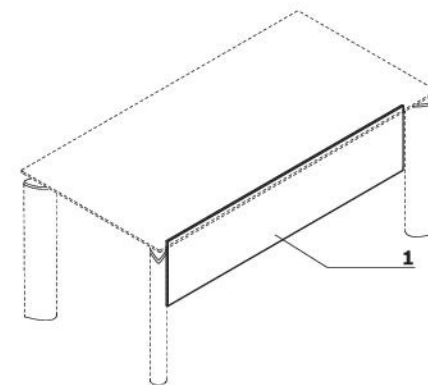
**Oslony przednie do biurkek - płytowe****1 Łączyna** - płyta melaminowana 18 mm, obrzeża ABS**Przystawka****1 Blat** - do wyboru:

- płyta melaminowana 12 mm, obrzeża ABS
- szkło hartowane, satynowane, matowe 10 mm, kolor: biały (ultra clear), czarny, malowane od spodu

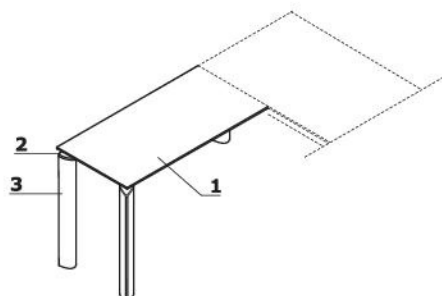
2 Element ozdobny - chromowany**3 Nogi** - profil aluminiowy, malowany proszkowo z detalami chromowanymi**Komoda****1 Wieniec górny** - do wyboru:

- płyta melaminowana 12 mm, obrzeża ABS
- szkło hartowane, satynowane 10 mm, malowane od spodu

2 Boki - płyta melaminowana 18 mm, obrzeża ABS**3 Półka** - płyta melaminowana 18 mm, zabezpieczenie przed przypadkowym wysunięciem, obrzeża ABS**4 Front** - System "Push-to-Open" - do wyboru:

- płyta melaminowana 18 mm, obrzeża ABS
- szkło hartowane, satynowane 4 mm, malowane od spodu

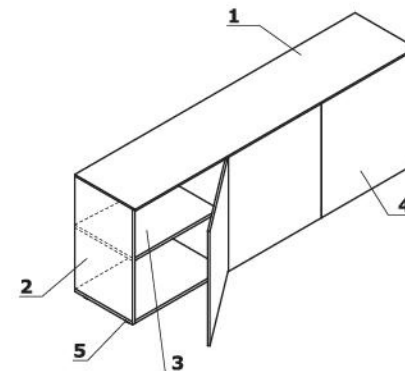
5 Stopki - regulacja poziomu od wewnątrz w zakresie 5 mm

UWAGI - uniwersalna (lewa,prawa); - możliwość zastosowania do biurkek oraz do stołu konferencyjnego

Stół konferencyjny

1 **Blat** - do wyboru:

- płyta melaminowana 12 mm, obrzeża ABS
- szkło hartowane, satynowane, matowe 10 mm, kolor: biały (ultra clear), czarny, malowane od spodu

2 **Element ozdobny** - chromowany3 **Nogi** - profil aluminiowy, malowany proszkowo z detalami chromowanymi4 **Profil** - metal malowany proszkowo, kolor: 08 czarny5 **Regulator poziomu** - regulacja w zakresie 5 mm6 **OPCJA Z DOPLATĄ** - wyłącznie do biurek z blatem płytowym:

- **Mediport S91E** - 2x 230V, 2x RJ45
- **Mediport S92E** - 4x 230V, 4x RJ45

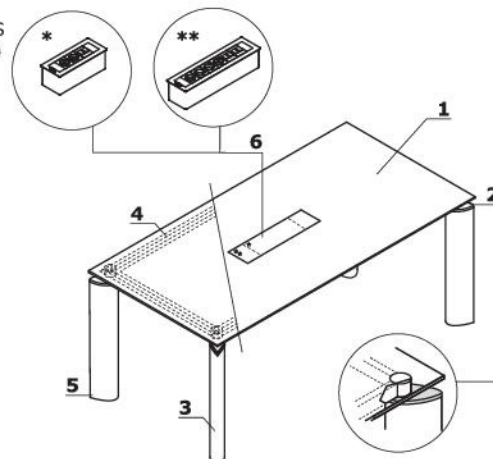

* Mediport S91E, **Mediport S92E

Kontenery bezuchwytowe - mobilne

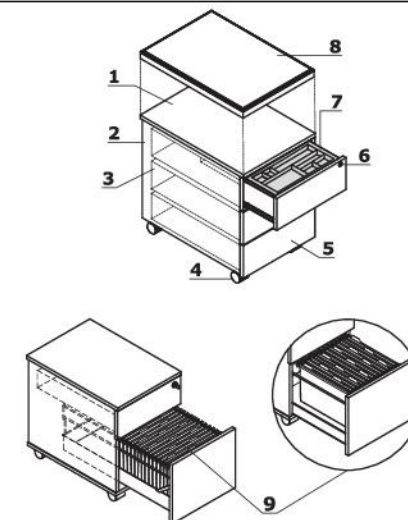
1 **Wieniec górny** - płyta melaminowana 18 mm, pokryta HPL - połysk2 **Korpus** - płyta melaminowana 18 mm, obrzeża ABS3 **Szufłady metalowe** - prowadnice rolkowe, nośność 25 kg, wysunięcie 80%, blokada wysuwu drugiej szufłady; OPCJA Z DOPLATĄ - system samodomyku, prowadnice kulkowe4 **Kółka** - Ø50 mm, dwa z hamulcem5 **Front** - płyta melaminowana 18 mm, pokryta HPL - połysk, obrzeża ABS6 **Zamek centralny** - łamany kluczyk7 **Piórnik nakładany** - tworzywo czarne8 **Opcjonalna poduszka SKP13** - nakładana na kontener, zamawiana jako osobny element, max obciążenie 120 kg9 **Szufłada filowa** - prowadnice kulkowe, max. obciążenie 30 kg, wysunięcie 100%, dla teczek A4 usytuowanie równoległe i prostopadłe do frontu

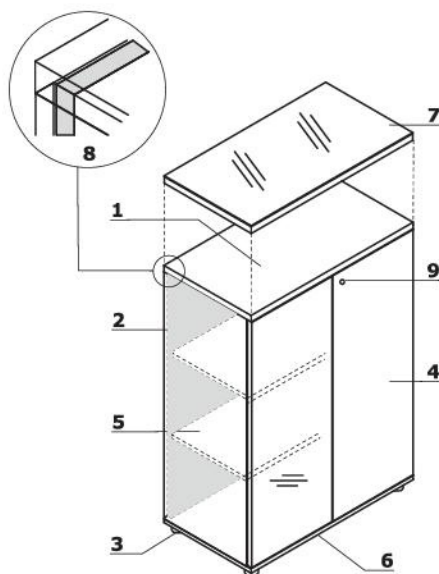

UWAGI - Możliwość siedzenia na kontenerach wyłącznie po zamocowaniu poduszki (SKP13); kontener z poduszką służy wyłącznie do siedzenia - przemieszczanie się na kontenerze podczas siedzenia, może spowodować uszkodzenie kółek

Szafy z frontem HPL



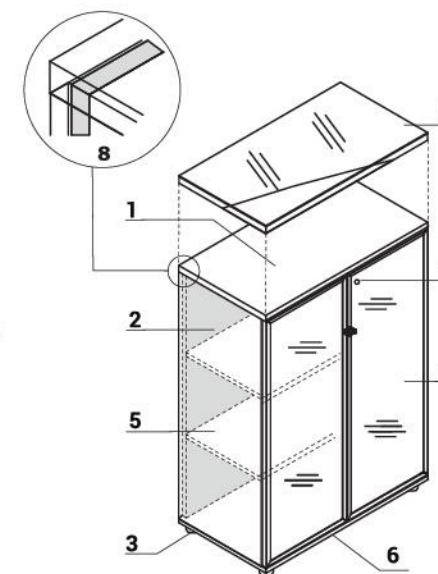

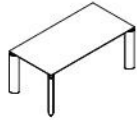
1 **Wieniec górny** - płyta melaminowana 28 mm, obrzeża ABS2 **Boki** - płyta melaminowana 18 mm, obrzeża ABS3 **Stopki 27 mm** - regulacja poziomu od wewnątrz w zakresie 5 mm4 **Front** - system "Push-to-Open", płyta melaminowana 18 mm pokryta HPL - połysk5 **Półka** - płyta melaminowana 18 mm, zabezpieczenie przed przypadkowym wysunięciem, obrzeża ABS6 **Wieniec dolny** - płyta melaminowana 18 mm, obrzeża ABS7 **OPCJA Z DOPLATĄ** - wieniec górny A800GT - płyta melaminowana 28 mm + szkło LACOBEL 4 mm, zamawiany jako oddzielny element8 **Ściana tylna** - płyta melaminowana 18 mm, obrzeża ABS9 **Zamek patentowy**

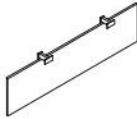
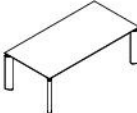
Witryny

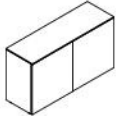
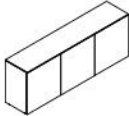

1 **Wieniec górny** - płyta melaminowana 28 mm, obrzeża ABS2 **Boki** - płyta melaminowana 18 mm, obrzeża ABS3 **Stopki 27 mm** - regulacja poziomu od wewnątrz w zakresie 5 mm4 **Front** - szkło hartowane bezbarwne w ramce aluminiowej5 **Półka** - płyta melaminowana 18 mm, zabezpieczenie przed przypadkowym wysunięciem, obrzeża ABS6 **Wieniec dolny** - płyta melaminowana 18 mm, obrzeża ABS7 **OPCJA Z DOPLATĄ** - wieniec górny A800GT - płyta melaminowana 28 mm + szkło LACOBEL 4 mm, zamawiany jako oddzielny element8 **Ściana tylna** - płyta melaminowana 18 mm, obrzeża ABS9 **Uchwyt** - aluminium

Biurka							
	Symbol		Wymiary			Waga Obj. Opak.	Uwagi
			Szer.	Gł.	Wys.		
	AE4		1600	800	760	36 kg 0.166 m ³ 6 szt.	
	AE4S		1600	800	760	86.4 kg 0.203 m ³ 6 szt.	blat szklany
	AE5		1800	900	760	40.5 kg 0.19 m ³ 6 szt.	
	AE5S		1800	900	760	107.3 kg 0.237 m ³ 6 szt.	blat szklany
	AE6		2000	900	760	44 kg 0.203 m ³ 6 szt.	
	AE6S		2000	900	760	119.3 kg 0.254 m ³ 6 szt.	blat szklany
Przystawki do biurek							
	AE7		1200	600	760	21 kg 0.09 m ³ 4 szt.	
	AE7S		1200	600	760	50.6 kg 0.113 m ³ 4 szt.	blat szklany
	AE8		800	600	760	17 kg 0.073 m ³ 4 szt.	
Oslony płytowe do biurek							
	AE4B		1400	18	350	9.1 kg 0.021 m ³ 2 szt.	do biurka 1600 mm
	AE5B		1600	18	350	9.3 kg 0.023 m ³ 2 szt.	do biurka 1800 mm
	AE6B		1800	18	350	10.85 kg 0.026 m ³ 2 szt.	do biurka 2000 mm
Stół konferencyjny							
	AE11		2200	1100	760	53.4 kg 0.255 m ³ 7 szt.	
	AE11S		2200	1100	760	136 kg 0.248 m ³ 6 szt.	blat szklany

Dodatkowa dopłata									
edlaport S91E	edlaport S92E								

Kontenery bezuchwytowe - mobilne							
	Symbol		Wymiary			Waga Obj. Opak.	Uwagi
			Szer.	Gł.	Wys.		
	SLD12HT		416	600	587	23 kg 0.158 m3 1 szt.	mobilny z szufladą na file, głębokość szuflad – 500 mm; front i wieniec górny - HPL, całość w jednym kolorze
	SLD13HT		416	600	587	23 kg 0.158 m3 1 szt.	mobilny; głębokość szuflad – 500 mm; front i wieniec górny - HPL, całość w jednym kolorze
Szafy							
	A2104HZ		801	432	777	43.45 kg 0.093 m3 3 szt.	front HPL, 20H
	A3104HZ		801	432	1129	60.2 kg 0.12 m3 3 szt.	front HPL, 30H
	A5104HZ		801	432	1833	106.55 kg 0.231 m3 5 szt.	front HPL, 50H
	A3404HZ		801	432	1129	54.7 kg 0.111 m3 3 szt.	front HPL, 30H
	A5404HZ		801	432	1833	92.9 kg 0.205 m3 5 szt.	front HPL, 50H
	AE21		1334	432	740	62.5 kg 0.122 m3 2 szt.	komoda
	AE21S		1334	432	740	81.4 kg 0.122 m3 2 szt.	komoda
	AE20		2000	432	740	96.2 kg 0.15 m3 2 szt.	komoda
	AE20S		2000	432	740	123.95 kg 0.15 m3 2 szt.	komoda ze szkłem
Witryny							
	A3104W		801	432	1129	53.25 kg 0.13 m3 3 szt.	szkło hartowane bezbarwne w ramce aluminiowej, 30H
	A5104W		801	432	1833	82.9 kg 0.232 m3 3 szt.	szkło hartowane bezbarwne w ramce aluminiowej, 50H
	A5404WZ		801	432	1833	86.7 kg 0.228 m3 4 szt.	

system samodomnyku	rowadnice kulkowe	okół metalowy	pp szklany A800GT				

Akcesoria							
	Symbol		Wymiary			Waga Obj. Opak.	Uwagi
			Szer.	Gł.	Wys.		
	SKP13		400	600	52	2.6 kg 0.017 m3 1 szt.	poduszka na kontener
	EK1200		1496	85	94	3.4 kg 0.01 m3 2 szt.	kanał kablowy do biurka 1600 mm; kolor: M115 - czarny półmat, M015 - biały półmat
	EK1400		1696	85	94	3.9 kg 0.012 m3 2 szt.	kanał kablowy do biurka 1800 mm; kolor: M115- czarny półmat, M015 - biały półmat
	EK1600		1896	85	94	4.2 kg 0.013 m3 2 szt.	kanał kablowy do biurka 2000 mm; kolor: M115 - czarny półmat, M015 - biały półmat

I grupa cenowa	II grupa cenowa	III grupa cenowa					



Płyta

 08 - czarny	 31 - dąb kanadyjski	 34 - kasztan	 67 - biały pastel	 167 - dąb szary	 168 - dąb naturalny	 171 - orzech ciemny
--	--	---	---	--	--	--











Metal

 M015 - biały półmat RAL 9010	 M115 - czarny półmat RAL 9005
---	--

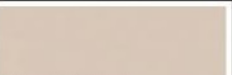

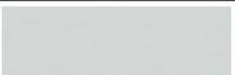





Szkło

 116 - szkło czarne - RAL 9005	 117 - szkło białe - RAL 9003
--	---



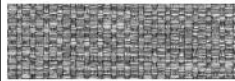







HPL

 73 - biały połysk	 101 - czarny połysk	 155 - antracyt połysk	 148 - szary połysk				
 174 - beżowy mat	 175 - truflowy mat	 176 - czerwony mat	 177 - szary mat RAL 7042	 178 - avocado mat	 179 - zielony butelkowy mat	 180 - błękitny pruski mat	 184 - błękitny mat

Tkanina Nemo - I grupa cenowa

 NE-1 - beżowy	 NE-2 - żółty	 NE-3 - pomarańczowy	 NE-5 - czerwony	 NE-9 - zielony	 NE-10 - szary	 NE-14 - grafitowy	 NE-15 - granatowy
 NE-16 - czarny	 NE-17 - niebieski						









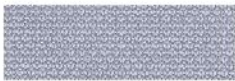

Tkanina Runner - II grupa cenowa

 R-63034 - pomarańczowy	 R-64089 - czerwony	 R-66063 - niebieski	 R-60011 - szary	 R-68056 - zielony	 R-66064 - granatowy	 R-60999 - czarny	 R-60025 - grafitowy
 R-61128 - beżowy	 R-61130 - brązowy						

Tkanina Medley - II grupa cenowa

 M-66008 - szary	 M-60003 - jasny szary	 M-61189 - beżowy	 M-68005 - oliwka ciemna	 M-62002 - żółty	 M-62054 - musztardowy	 M-63017 - rdzawy	 M-64019 - czerwony
 M-63064 - różowy	 M-65011 - szaro fioletowy	 M-66010 - niebieski	 M-67006 - niebieski jasny	 M-60999 - czarny			

Tkanina Atlantic - II grupa cenowa (Pozostałe kolory Atlantic wg wzornika Gabriel dostępne w terminie nie krótszym niż 7 dni roboczych)

 A-67043 - ciemny turkus	 A-67030 - morski	 A-60141 - jasnoszary	 A-60011 - szary	 A-66064 - granatowy	 A-65037 - fioletowy	 A-62048 - oliwkowy	 A-64089 - czerwony
 A-61078 - beżowy	 A-60025 - grafitowy						

Tkanina Go check - II grupa cenowa

 G-66136 - niebieski	 G-66137 - niebieski ciemny	 G-66134 - fiolet ciemny	 G-66138 - granatowy	 G-66140 - atramentowy	 G-68149 - ciemny zielony	 G-68152 - zielony	 G-60079 - szary
 G-64183 - marsala	 G-63079 - pomarańczowy	 G-64171 - czerwony	 G-64172 - bordowy	 G-61144 - brązowy	 G-61145 - brązowy ciemny		

Tkanina Charles - II grupa cenowa

 C-01 - czarny	 C-05 - szary	 C-06 - beżowy	 C-14 - brązowy	 C-18 - rdzawy	 C-21 - czerwony	 C-30 - różowy	 C-31 - marsala
 C-32 - niebieski ciemny	 C-35 - niebieski	 C-41 - żółty	 C-44 - oliwkowy	 C-45 - zielony			

Tkanina Synergy - III grupa cenowa

 LDS08 - szary melanz	 LDS20 - jasny szary	 LDS27 - czarny	 LDS29 - ciemny szary	 LDS50 - ciemny zielony	 LDS53 - zielony	 LDS57 - turkusowy	 LDS60 - zielony butelkowy
 LDS61 - śliwkowy	 LDS69 - granatowy	 LDS84 - pomarańczowy	 LDS86 - czerwony	 LDS88 - oberżyna	 LDS85 - koralowy	 LDS19 - beżowy	 LDS44 - żółty
 LDS79 - brązowy							











Tkanina Xtreme - III grupa cenowa

 XR108 - beżowy	 XR094 - szary	 XR081 - ciemny szary	 XR420 - oliwkowy	 XR009 - czarny	 XR026 - granatowy	 YS071 - jasny brąz	 YS030 - bordowy
 YS076 - pomarańczowy	 YS072 - żółty	 YS045 - zielony	 YS100 - niebieski				

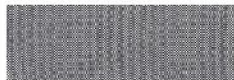
Tkanina Atlas - IV grupa cenowa

 AS-531 - pomarańczowy	 AS-501 - różowy	 AS-651 - czerwony	 AS-681 - bordowy	 AS-391 - brązowy	 AS-781 - granatowy	 AS-161 - ciemny szary	 AS-111 - jasny szary
 AS-971 - jasny zielony	 AS-981 - ciemny zielony						

Tkanina Field2 - IV grupa cenowa

 FD-463 - żółty	 FD-963 - zielony	 FD-123 - beżowy	 FD-132 - szary	 FD-142 - grafit	 FD-662 - czerwony	 FD-782 - granatowy	 FD-693 - bordowy
 FD-192 - czarny	 FD-673 - niebiesko-czerwony						