

.mdd

Budki akustyczne

v1.1 / 03.10.2023

Zestawienie kolorystyczne - Coda

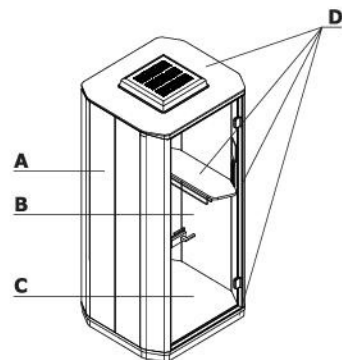

| Materiał | Kolor | Coda | | | | | | | | | | | | | | | | |
|----------|---------------------------------------|-------------------------|-------------------------|-------------|---|--|--|---|--|--|--|--|--|--|--|--|--|--|
| | | A - Ściany - zewnętrzne | B - Ściany - wewnętrzne | C - Podłoga | D - Dach, ramy okien i drzwi, półka, klamki | | | | | | | | | | | | | |
| Metal | M012 - ciemny zielony półmat RAL 6012 | ✓ | | | | | | | | | | | | | | | | |
| | M013 - bordowy półmat RAL 3007 | ✓ | | | | | | | | | | | | | | | | |
| | M015 - biały półmat RAL 9010 | ✓ | | | | | | | | | | | | | | | | |
| | M028 - ceglasty półmat RAL 040404 | ✓ | | | | | | | | | | | | | | | | |
| | M030 - beżowy półmat RAL 0608005 | ✓ | | | | | | | | | | | | | | | | |
| Tkanina | Medley | | ✓ | | | | | | | | | | | | | | | |
| | **Atlantic | | ✓ | | | | | | | | | | | | | | | |
| | ***Charles | | ✓ | | | | | | | | | | | | | | | |
| | Go Check | | ✓ | | | | | | | | | | | | | | | |
| | Mica | | ✓ | | | | | | | | | | | | | | | |
| | Synergy | | III grupa | | | | | | | | | | | | | | | |
| | Tessa | | III grupa | | | | | | | | | | | | | | | |
| | Oceanic | | III grupa | | | | | | | | | | | | | | | |
| | Quest | | III grupa | | | | | | | | | | | | | | | |
| | Grain | | III grupa | | | | | | | | | | | | | | | |
| | *Tkanina powierzona | | III grupa | | | | | | | | | | | | | | | |
| | Atlas | | IV grupa | | | | | | | | | | | | | | | |
| Czarny | | | | | | | | ✓ | | | | | | | | | | |
| Grafit | | | | ✓ | | | | | | | | | | | | | | |

Opis techniczny

- 1 Sufit** - płyta MDF lakierowana, tapicerowana, kolor: LDS20 - szary; wyposażony w oświetlenie i wentylator
- 2 Wentylator** - montowany w suficie z możliwością regulacji siły nawiewu
- 3 Czujnik ruchu** - aktywacja oświetlenia, wentylatorów, panela dotykowego oraz lampek sygnalizacyjnych
- 4 Lampki sygnalizacyjne** - 4 szt.; światło czerwone - zajęte, światło zielone - wolne
- 5 Panel sterowania** - regulacja natężenia oświetlenia oraz siły nawiewu
- 6 Ściana tapicerowana** - blacha, grubość 1mm; wypełniona pianką akustyczną, tapicerowana od wewnętrznej strony
- 7 Mediabox** - 2x230V + 1 x USB A + 1 x USB C
- 8 Półka** - MDF 19mm, stelaż - pręt stalowy Ø6 mm; kolor: czarny
- 9 Ściana szklana** - szkło akustyczne bezpieczne, grubość 10mm, profil aluminiowy 52x45mm
- 10 Drzwi szklane** - szkło akustyczne bezpieczne, grubość 10mm; wyposażenie: zawiasy, klamkę i system uszczelek
- 11 Podłoga** - płyta MDF 31mm + wykładzina akustyczna
- 12 Kółka** - zakryte cokołem, umożliwiają łatwe przemieszczenie budki
- 13 Przyłącze elektryczne** - wyjście na kabel w dachu lub w cokole

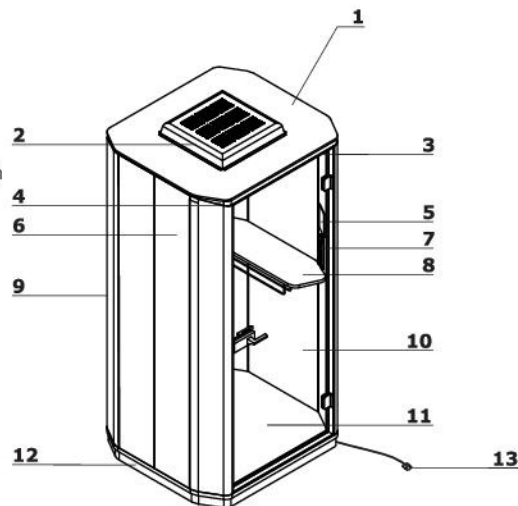

Wymiary (mm)

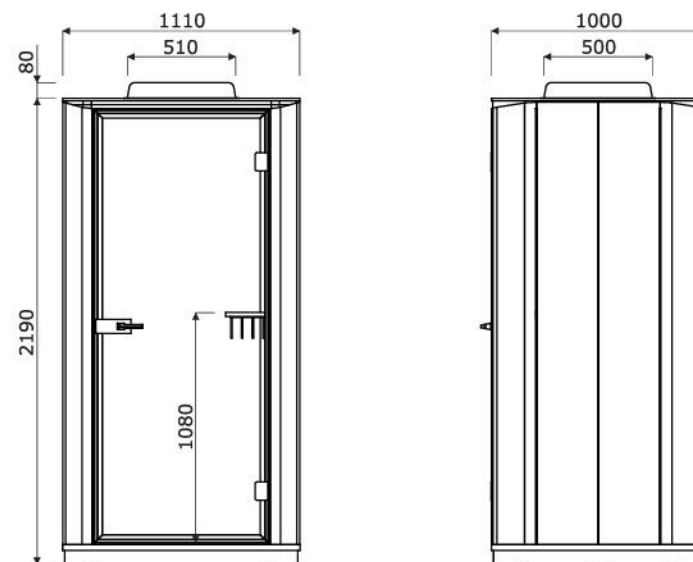

| Coda | | | | | | |
|---|-------------|---------|------|------|------------------------------|-------|
|  | Symbol | Wymiary | | | Waga Obj. Opak. | Uwagi |
| | | Szer. | Gł. | Wys. | | |
| | CD01 | 1112 | 1051 | 2196 | 335 kg 2.566 m3 1 szt. | |

| I grupa cenowa | II grupa cenowa | | | | | | |
|----------------|-----------------|--|--|--|--|--|--|
| | | | | | | | |

Metal

| | | | | |
|--|---|---|--|---|
|  M012 - ciemny zielony półmat RAL 6012 |  M013 - bordowy półmat RAL 3007 |  M015 - biały półmat RAL 9010 |  M028 - ceglasty półmat RAL 0404040 |  M030 - beżowy półmat RAL 0608005 |
|--|---|---|--|---|

Tkanina Mica - II grupa cenowa

| | | | | | | | |
|--|---|--|---|--|--|--|--|
|  MC-2496-64183 - różowy |  MC-2496-64146 - czerwony |  MC-2497-64146 - ciemny czerwony |  MC-2497-66006 - granatowy |  MC-2496-66030 - niebieski |  MC-2497-67042 - morski |  MC-2497-67017 - zielony butelkowy |  MC-2497-68146 - zielony |
|  MC-2497-62048 - oliwkowy |  MC-2496-62093 - jasny oliwkowy |  MC-2496-62095 - musztardowy |  MC-2496-62096 - żółty |  MC-2496-61008 - beżowy |  MC-2496-60000 - jasny szary |  MC-2497-60000 - szary |  MC-2497-60021 - grafitowy |
|  MC-2496-66031 - niebieski jasny |  MC-2496-67015 - miętowy |  MC-2497-64029 - bordowy | | | |  M015 - biały półmat RAL 9010 | |

Tkanina Medley - II grupa cenowa

| | | | | | | | |
|--|--|---|--|--|--|---|---|
|  M-66008 - szary |  M-60003 - jasny szary |  M-61189 - beżowy |  M-68005 - ciemny oliwkowy |  M-62002 - żółty |  M-62054 - musztardowy |  M-63017 - rdzawy |  M-64019 - czerwony |
|  M-63064 - różowy |  M-65011 - szarofioletowy |  M-66010 - niebieski |  M-67006 - jasny niebieski |  M-60999 - czarny | | | |

Tkanina Go check - II grupa cenowa

| | | | | | | | |
|--|---|---|---|--|---|--|--|
|  G-66136 - niebieski |  G-66137 - niebieski ciemny |  G-66134 - ciemny fioletowy |  G-66138 - granatowy |  G-66140 - atramentowy |  G-68149 - ciemny zielony |  G-68152 - zielony |  G-60079 - szary |
|  G-64183 - marsala |  G-63079 - pomarańczowy |  G-64171 - czerwony |  G-64172 - bordowy |  G-61144 - brązowy |  G-61145 - ciemny brązowy | | |











Tkanina Charles - II grupa cenowa (Istnieje możliwość zamówienia produktu w pełnej kolorystyce Charles wg wzornika Dekoma w standardowym terminie realizacji.)

| | | | | | | | |
|--|---|--|---|---|--|--|---|
|  C-01 - czarny |  C-05 - szary |  C-06 - beżowy |  C-14 - brązowy |  C-18 - rdzawy |  C-21 - czerwony |  C-30 - różowy |  C-31 - marsala |
|  C-32 - niebieski ciemny |  C-35 - niebieski |  C-41 - żółty |  C-44 - oliwkowy |  C-45 - zielony | | | |

Tkanina Synergy - III grupa cenowa

| | | | | | | | |
|---|--|---|--|---|---|--|--|
|  LDS08 - szary melanz |  LDS20 - jasny szary |  LDS27 - czarny |  LDS29 - ciemny szary |  LDS50 - ciemny zielony |  LDS53 - zielony |  LDS57 - turkusowy |  LDS60 - zielony butelkowy |
|  LDS61 - śliwkowy |  LDS69 - granatowy |  LDS84 - pomarańczowy |  LDS86 - czerwony |  LDS88 - oberżyna |  LDS85 - koralowy |  LDS19 - beżowy |  LDS44 - żółty |
|  LDS79 - brązowy | | | | | | | |

Tkanina Oceanic - III grupa cenowa

| | | | | | | | |
|--|---|---|---|--|--|--|--|
|  O-16 - różowy |  O-05 - koralowy |  O-12 - czerwony |  O-07 - żółty |  O-04 - jasny zielony |  O-15 - jasny niebieski |  O-11 - niebieski |  O-13 - jasny szary |
|  O-08 - ciemny szary |  O-01 - czarny | | | | | | |

Tkanina Silvertex - III grupa cenowa - Istnieje możliwość zamówienia produktu w pełnej kolorystyce Silvertex wg wzornika Spradling w terminie nie krótszym niż 15 dni roboczych.

Tkanina Quest - III grupa cenowa

| | | | | | | | |
|---|--|--|--|--|--|---|---|
|  Q-26 - różowy |  Q-25 - pomarańczowy |  Q-24 - czerwony |  Q-21 - pastelowy żółty |  Q-19 - beżowy |  Q-18 - oliwkowy |  Q-13 - jasny zielony |  Q-08 - granatowy |
|  Q-07 - jasny niebieski |  Q-04 - grafitowy | | | | | | |

Tkanina Grain - III grupa cenowa

| | | | | | | | |
|--|---|--|---|--|--|---|---|
|  GR-64249 - różowy |  GR-62122 - żółty |  GR-62016 - jasny pomarańczowy |  GR-63117 - pomarańczowy |  GR-68243 - oliwkowy |  GR-66236 - błękitny |  GR-66232 - granatowy |  GR-60301 - szary |
|  GR-61252 - beżowy |  GR-61250 - biały | | | | | | |

Tkanina Atlas - IV grupa cenowa

| | | | | | | | |
|--|---|--|--|---|---|--|---|
|  AS-531 - pomarańczowy |  AS-501 - różowy |  AS-651 - czerwony |  AS-681 - bordowy |  AS-391 - brązowy |  AS-781 - granatowy |  AS-161 - ciemny szary |  AS-111 - jasny szary |
|  AS-971 - jasny zielony |  AS-981 - ciemny zielony | | | | | | |